



240 | YEARS
OF LOCKMAKING EXCELLENCE



CATALOGUE 2023



www.squirelocks.co.uk

W. C. WEDGWOOD, BENTLEYS,
WALTONS TELESCOPE WORKS,
WOLFE, 7 BLOKWICH
LONDON, MOUNTVIEW 1904.

ON ADMIRALTY LIST, WAR OFFICE, INDIA OFFICE AND H. M. OFFICE OF WORKS.

HENRY SQUIRE & SONS, LTD

MACHINE MANUFACTURERS

BRASS FOUNDERS & STAMPERS



NEW INVENTION Near WOLVERHAMPTON,
ENGLAND.



INTRODUCING SQUIRE

We are proud to present our new 2023 catalogue. As a family business that began in 1780, we take huge pride in our craft and stand firmly behind our reputation for long lasting toughness that's guaranteed. That's why we offer a personal 10 year guarantee on every product.

Celebrating over 240 years of lock making

Squire has been at the forefront of international lock making for over 240 years. As an eighth generation independent family-owned lock manufacturer, Squire continues its tradition of offering high-quality, performance-led products at very competitive prices.

John Squire

CEO - 8th Generation



CONTENTS

INTRODUCTION

Introduction	3
Which category to use	5
Keyed alike, Master keyed	5
Quality and standards	5
Sustainability	6
New Products	8-11
Stronghold® 25th Anniversary	12

WORK

Introduction to WORK	13
Stronghold® Range	14
Warrior™ Combi Range	28
Warrior™ Key Range	30
General Use Padlocks	32
Combi-Bolt™ 5	33
Hasp and Staples	34
Lock and Chain Sets	36
Chains	38
Key Safes	40

HOME

Introduction to HOME	42
Vulcan™ Combi Range	44
Vulcan™ Key Range	46
CP Combination Range	48
Lion Range	50
Lion Sub Assembly	52
All Terrain	54
Old English	55
Stronglock™ Range	56
P4 Keyed Alike KIT	58
Keybolt™ , Hasp & Staples	61
Combi-Bolt™ 3 & 4	62

LEISURE

Introduction to LEISURE	64
CP All Terrain Range	66
Leisure Padlock Range	68
Leisure Marine Grade	69

GENERAL SECURITY PRODUCTS

Hasp and Staples	72
Chains Range	74
Lock and Chain Sets	77
Garage Security	80
Ground and Wall Anchors	81
Bike Locks - KILDA and FOLDA	82
Keys and Key Blanks	84
Merchandisers	86
Terms and conditions	88



240|YEARS
OF LOCKMAKING EXCELLENCE

WHICH CATEGORY TO CHOOSE



WORK

Use: trade use, toolbox, container, commercial vehicle, outbuilding / warehouse, security gate garage forecourt

SECURITY RATING
maximum 6-10

HOME

Use: all-round home use, garage, shed, front gate, storage

SECURITY RATING
high 2-7

LEISURE

Use: out and about, recreational gear, suitcase, caravan / camping, bbq, sport locker, marine

SECURITY RATING
basic 1-7

KEYED ALIKE AND MASTER KEYED SERVICES

Throughout this price list, you will find that some of our locks are available either as a standard lock, Keyed Alike or Master Keyed. Here we explain what each type of lock can do, to assist you in your product selection.

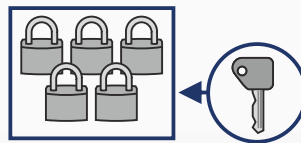

Keyed Alike System

Keyed Alike - Where two or more padlocks can be operated with the same key. For 4 pin tumbler locks there are over 1000 different Keyed Alike combinations, for 5 pin there are over 1500 and for 6 pin tumbler locks there are over 250,000 differed Keyed Alike combinations.

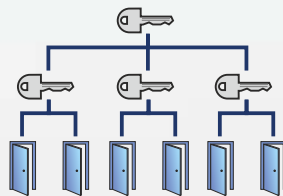

Master Key System

Master Keyed - Padlocks keyed so that each padlock is different yet a Master Key will open them all. A Master Keying surcharge is applicable, see the footnote after each product listing.

QUALITY AND STANDARDS



Raising Standards
Safety Assured



Squire products are covered by a variety of industry accreditations. Much of the Squire cycle range and certain padlocks are Sold Secure approved meaning that they have been independently attack tested. Sold Secure products are also supported by Secured by Design which was initiated by the British Police Force.

Squire have a number of **Stronghold**® products that achieve LPCB (Loss Prevention Certification Board) approval which is the UK's most stringent approval body and many other padlocks within the Stronghold range meet the CEN EN 12320 Standard.



SUSTAINABILITY

Here at Squire we are committed to promoting sustainability. We aim to follow and to promote good sustainability practice, to reduce the environmental impacts of all our activities and to help our clients and partners to do the same.

Squire has been accredited to the Environmental Management standard ISO 14001 since 2010. We strive to actively improve our environmental performance by focussing on reducing greenhouse gas emissions, energy & water consumption and waste, while increasing recycling and the use of alternative energy sources.

Minimising energy consumption

In practical terms, Squire has supplemented its energy consumption with power generated by almost 820m² of solar panels providing almost 40% of our annual electrical consumption. All lighting has been converted to LED controlled by motion sensors and energy efficient air conditioning units have been installed to replace older and less effective systems. Squire has invested in a fleet of hybrid vehicles for our sales personnel and a recharging station has been installed for employees who drive plug-in electric vehicles.

Carbon emissions

Since 2020, Squire has offset all its Scope 1, 2 & 3 carbon emissions. Squire have supported projects such as tree planting in the UK, providing clean cookstoves in Kenya, renewable energy projects in India and protection of rainforests in the Amazon.

Recycling

In 2022, Squire switched to a sustainable, carbon neutral waste management company for the removal and disposal of our general factory waste. This ensures our waste is either re-used or recycled, with zero waste to landfill.

Social Responsibilities and charitable work

We are aware that the running of our business will, in many ways, affect our place of work, the community and the wider environment in which we operate. We believe that the way we run our business can and should make a positive difference in these areas and we aim to ensure that continued efforts are made to achieve that. We are committed to providing an environment of equal opportunities for all members of our workforce and are keen to support and be involved in community initiatives and charitable work.

Packaging

The use of plastics in our packaging is gradually being phased out as we strive to utilise more easily recyclable media in a variety of different formats.

Customer expectations are at the forefront as we develop new methods to protect and present our products, whilst ensuring 100% recyclability. The move away from plastic packaging to cardboard is designed to offer stockists a more environmentally friendly option. We offer retailers a choice of packaging with our new printed boxes. Boxed products are now available as an option across a wide range of our combination padlocks, including our Stronghold®, Vulcan and Warrior ranges. And boxed products can be displayed in a new counter merchandiser unit made of sustainable wood materials.



Sponsorship with Bilbrook Junior Football Club for the 2022/23 season which sees our Squire logo front and centre of every shirt for all 34 teams, including U6 to U19 boys, and U11 and U14 girls.



Sending essentials such as medicines, first aid kits, long-life food and bottled water, as well as blankets, sleeping bags and toiletries to support Ukrainian civilians in the recent conflict.



New Products

Old English 555 - The ultimate marine padlock

The 555 can withstand total submersion under water.

Central to this lock's incredible performance in wet conditions is its four-level lock mechanism made from brass with electrophoretic nickel coating. These locks have been salt spray tested to 480 hours and meet the highest European corrosion resistance standard (EN 1670 - Grade 5). (see page 70)

DCL1 Combi

Based upon Squire's popular DCL1, the DCL1 Combi features the same stainless steel body and hardened boron alloy steel shackle, but now with the added convenience of a combination mechanism. (see page 32)

Lion Premium Brass, Sub Assembled - Special Service

Squire can build, in-house, Keyed Alike padlock suites within the Lion range, guaranteed Keyed to differ, guaranteed non inter-passing. Customers can forget concerns of possible key duplication using this new in-house service. (See page 52)

CP All Terrain

The new CP All Terrain locks combine all of the features of Squire's highly popular CP combination range with added weather protection features. Tested to 312 hours salt spray. Available in standard dark blue, high visibility orange and RUSTPROOF light blue versions (see page 66).

Leisure Marine Grade

Squire have a new LEISURE - MARINE GRADE range. This category of locks is an extension of the regular LEISURE range having features that enhance performance in wet conditions. Many locks in this range have been salt spray tested (see page 69).

GA7 Ground anchor

A new ground anchor, slightly smaller than the GA6, though still achieving Sold Secure Gold Motorcycle and Sold Secure Diamond Bicycle Approval (see page 81).





New for 2023

Elite Dimple Pin as standard

On SS80, SS65, SS50 and WS75

Ranges at no extra cost

Squire are now offering Elite dimple pin key as standard on various **Stronghold**® products. Squire understand that some customers may specifically request this kind of key from their locksmith. Now locksmiths can support this across the **Stronghold**® range at no extra cost to the customer. Squire's dimple pin key system is patented until 2034 and offers 470,000 key differs - over 200,000 more than on their standard **Stronghold**® key.

Choice of boxed or retail pack packaging

As part of Squire's ongoing commitment to the environment, all **Stronghold**® products originally available in retail packs are now also available in attractive printed boxes.



New for 2023

KILDA cable locks and integrated chains

Our latest range of cable locks and integrated locks and chains, ideal for locking bikes, ladders, tools etc. Security rated, easy to use, convenient. Choose from cable locks or lock and chain sets with combination or key operated padlocks (see page 82-83).



KILDA Packaging



KILDA Cable Locks

FOLDA folding locks

Two new super-lightweight folding locks designed for the urban cyclist. Compact, convenient, easy to carry, FOLDA FL850 and FOLDA FL690 come with holster and carrying bracket. The FOLDA FL850 achieves Sold Secure Bronze Cycle approval (see page 82-83).



FOLDA FL850

FOLDA Folding Locks



KILDA Security Cables



STRONGHOLD[®] Made in Britain since 1998

2023 Sees the 25th Anniversary of Squire's highest security padlock. Stronghold padlocks are still made in Britain to this day and have earned a reputation for being some of the most durable and reliable locks on the market.

The range has grown extensively since their conception in 1998, now available in a number of body widths and shackle types. Over the years, they have gained numerous industry accreditations. Including CEN, Sold Secure, Secured by Design and LPCB. The largest lock in the range, the SS100CS is the world's first padlock to achieve LPCB level 4*.



* As a stand alone padlock and not part of a lock and chain set

WORK

Work category locks includes our flagship **Stronghold®** range, great for securing warehouses, shipping containers, or heavy machinery. We've also got more portable locks for toolboxes or vans.

Product usage

- Trade use
- Toolbox
- Container
- Commercial vehicle
- Outbuilding / warehouse
- Security gate
- Garage forecourt

Why choose WORK

- Heavy-duty
- Precision **Stronghold®** locks
- Super-tough rust and storm-proofed
- Guaranteed 10 years
- Thief-proof tested

Security rating

maximum 6-10

Squire WORK models

- **Stronghold®**
- **Stronghold®** Combi
- **Warrior™** Key
- **Warrior™** Combi
- **SHCB** Combination
- **CBW85** Combination
- Padbars & high security hasps
- High security chains



Stronghold® Padlock Range



Stronghold® range of extra high security padlocks

A range of super-tough, high security padlocks tested to the limits in-house and achieves accreditation by independent bodies such as CEN, LPCB, Sold Secure and Secured by Design. Made in Britain, these padlocks come in a variety of body widths and shackle versions.

Features

Hardened boron alloy steel shackle

Solid hardened steel lock body

Electrophoretic anti-corrosion finish

6 pin cylinder - over 250,000 key differs

Anti-drill protection

Protective dust cover

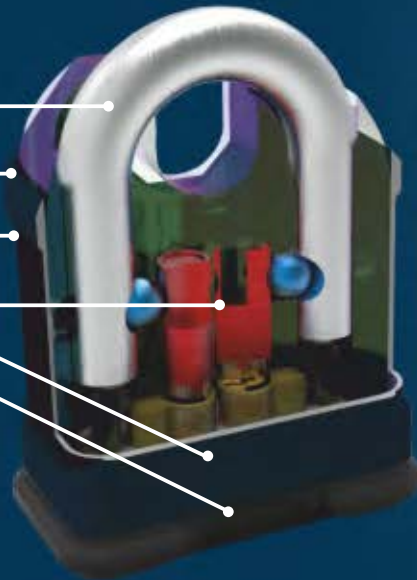

Stronghold® products are now available with Elite dimple pin key as standard, except for the SS100 range



Boron steel shackle

Stronghold® Range



CEN Grade

Tested to European CEN standards for padlock and padbar fittings BS EN12320

CEN Ratings

SS100CS	CEN6	SS50CS	CEN4
SS100S	CEN6	SS50S	CEN4
SS80CS	CEN6	SS50S/2.5	CEN4
SS80S	CEN6	SS50CP5	CEN3
SS65CS	CEN6	SS50P5	CEN3
SS65S/2.5	CEN5	SS50P5/2.5	CEN3
SS65S	CEN5	WS75S	CEN4
SS65HE	CEN5	SS55HE	CEN3
SS65/2.5HE	CEN5	SS55/2.5HE	CEN3

'E' variants have the same accreditation as 'S' versions.
Scan Ovals have the same accreditations as 'S' versions.
Marine versions also have CEN accreditations, see page 16.

Pinning kit available to masterkey and key alike 6 pin models. Separate pinning kit available to masterkey and key alike 5 pin models. Details available page 20.

Stronghold® SS100

The world's strongest production padlock

The SS100S and SS100CS are the latest additions to the **Stronghold®** Range.

Designed as the world's strongest production padlock, the SS100 is the first padlock to achieve LPCB SR4 (Loss Prevention Certification Board) approval.

This outstanding British made heavy duty padlock - which is capable of a tensile pull of over 20 tonnes - has been approved to LPCB's standard LPS 1654: Issue 1.0 security rating classification SR4.

Squire's **Stronghold®** SS100CS features a 4.3kg solid steel lock body and 20mm diameter hardened boron steel shackle.

LPCB Ratings

One of the challenges of making buildings safe and secure, is selecting and installing fire safety and security products that actually do what they claim. The Loss Prevention Certification Board (LPCB) has been working with industry and government for more than 100 years to set the standards needed to ensure that security products perform effectively. LPCB offers third-party approval confirming that products meet these standards.

The SS100S and SS100CS meet LEV4. Under the current testing regime this is the highest level that any padlock can achieve when tested on its own. The SS80S and SS80CS meet LEV3. SS65S LEV3 and SS65CS LEV3 are enhanced versions of the standard padlocks which meet LEVEL 3 of the new LPS Standards for Standalone padlocks.

The SS65S LEV3 and SS65CS LEV3 meets LPS 1654 Issue 1, Security rating 3, Certificate number 1179a/02.

The standard SS50S and SS50CS meet LPS 1654 Issue 1, Security rating 2, Certificate number 1179a/01.

Several products now meet LPCB LPS 1654 Issue 1.

SR4	SR3	SR2
SS100CS	SS80CS	SS50CS
SS100S	SS80S	SS50S
	SS65CS LEV3	
	SS65S LEV3	

Stronghold® padlocks - SS100



The Stronghold® SS100^{NEW}
THE WORLD'S STRONGEST PADLOCK

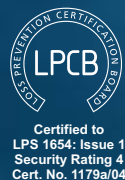

The first padlock ever to achieve LPCB Level SR4
LPCB's highest padlock accreditation

These massive, super-heavyweight padlocks are the newest addition to the Stronghold® range.

Features

- 100mm wide solid hardened steel lock body
- Open and closed shackle versions, SS100CS weighs 4.3kg
- 20mm diameter hardened boron alloy steel flying shackle
- Accredited to LPCB Level SR4 and CEN 6
- SS100CS with 22mm chain approved to Sold Secure Motorcycle Diamond standard
- Dual key operated, ideal for supervised use
- Two 6 pin cylinders, choice of same cylinder or keyed to differ, both can be keyed alike or master keyed
- Anti-drill protection
- Electrophoretic anti-corrosion finish
- Protective dust cover
- Tensile pull tested to 24 tonnes (independently verified)



Actual Size!!



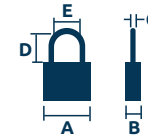

THE WORLD'S STRONGEST PADLOCK
Stronghold® SS100 range - 100mm wide body



SS100S

SS100CS

Code	LPCB	CEN	Security Rating	@	Description	Dimensions mm					Barcode	Key Blank	Pack Type	Min Qty	MK
						A	B	C	D	E					
SS100CS	SR4	CEN 6	10	WORK	100mm Closed Shackle comes with 2 same key cylinders	100	62	20	33	28	5012245 038149	KB P6	BOX	1	■
SS100CS/KD	SR4	CEN 6	10	WORK	100mm Closed Shackle comes with 2 differ key cylinders	100	62	20	33	28	5012245 038170	KB P6	BOX	1	■
SS100S	SR4	CEN 6	10	WORK	100mm Open Shackle comes with 2 same key cylinders	100	62	20	40	48	5012245 038088	KB P6	BOX	1	■
SS100S/KD	SR4	CEN 6	10	WORK	100mm Open Shackle comes with 2 differ key cylinders	100	62	20	40	48	5012245 038118	KB P6	BOX	1	■
SS100CS/KA	SR4	CEN 6	10	WORK	100mm Closed Shackle comes with 2 same key cylinders KA	100	62	20	33	28	5012245 038156	KB P6	BOX	1	
SS100CS/KD/KA	SR4	CEN 6	10	WORK	100mm Closed Shackle comes with 2 differ key cylinders KA	100	62	20	33	28	5012245 038187	KB P6	BOX	1	
SS100S/KA	SR4	CEN 6	10	WORK	100mm Open Shackle comes with 2 same key cylinders KA	100	62	20	40	48	5012245 038095	KB P6	BOX	1	
SS100S/KD/KA	SR4	CEN 6	10	WORK	100mm Open Shackle comes with 2 differ key cylinders KA	100	62	20	40	48	5012245 038125	KB P6	BOX	1	

Restricted profile available £18 surcharge
 MK denotes master keyed available £20 surcharge

Stronghold® SS80 range - 80mm wide body



SS80S

SS80CS

SS80CS	SR3	CEN 6	10	WORK	80mm Closed shackle steel lock 6 pin S cylinder	80	40	16	25	23.5	5012245035674	KB P6	PLATFORM	1	■
SS80CS/E1/SD		CEN 6	10	WORK	80mm Closed shackle steel lock 6 pin Elite Dimple cylinder	80	40	16	25	23.5	5012245040579	CYKEY/E1/BL	BOX	1	■
SS80S	SR3	CEN 6	10	WORK	80mm Open shackle steel lock 6 pin S cylinder	80	40	16	32	32	5012245035681	KB P6	PLATFORM	1	■
SS80S/E1/SD		CEN 6	10	WORK	80mm Open shackle steel lock 6 pin Elite Dimple cylinder	80	40	16	32	32	5012245040562	CYKEY/E1/BL	BOX	1	■
SS80CSKA	SR3	CEN 6	10	WORK	80mm KA Closed shackle steel lock 6 pin S cylinder	80	40	16	25	23.5	Special	KB P6	BOX	1	
SS80CS/E1/KA		CEN 6	10	WORK	80mm KA Closed shackle steel lock 6 pin Elite Dimple cylinder	80	40	16	25	23.5	Special	CYKEY/E1/BL	BOX	1	
SS80SKA	SR3	CEN 6	10	WORK	80mm KA Open shackle steel lock 6 pin S cylinder	80	40	16	32	32	Special	KB P6	BOX	1	
SS80S/E1/KA		CEN 6	10	WORK	80mm KA Open shackle steel lock 6 pin Elite Dimple cylinder	80	40	16	32	32	Special	CYKEY/E1/BL	BOX	1	

Restricted profile available
 MK denotes master keyed available



New Stronghold® SS100 POS board

The **SS100** is the newest addition to Squire's **Stronghold®** range. These stunning locks are now available on a Point of Sale, merchandiser board. Both versions, the open and closed version are displayed, fixed to a strong bracket. The board comes with 'J' Hooks supplied and loops prefixed to the back of the board for easy installation. Please contact your Squire representative for more details.

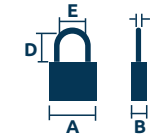

Stronghold® SS65 range - 65mm wide body



Code	LPCB	CEN	Security Rating	@	Description	Dimensions mm					Barcode	Key Blank	Pack Type	Min Qty	MK
						A	B	C	D	E					
SS65CS		CEN 6	10	WORK	65mm Closed shackle steel lock 6 pin S cylinder	65	31.8	12.7	19	19	5012245003918	KB P6	PLATFORM	3	■
SS65CS BOXED		CEN 6	10	WORK	65mm Closed shackle steel lock 6 pin S cylinder	65	31.8	12.7	19	19	Special	KB P6	BOX	1	■
SS65CS/E1/SD		CEN 6	10	WORK	65mm Closed shackle steel lock 6 pin Elite Dimple cylinder	65	31.8	12.7	19	19	5012245040548	CYKEY/E1/BL	BOX	1	■
SS65CS LEV3	SR3	CEN 6	10	WORK	65mm Closed shackle steel lock 6 pin S cylinder	65	31.8	12.7	19	19	5012245003918	KB P6	PLATFORM	3	■
SS65S		CEN 5	10	WORK	65mm Open shackle steel lock 6 pin S cylinder	65	31.8	12.7	29	29.5	5012245003994	KB P6	PLATFORM	3	■
SS65S BOXED		CEN 5	10	WORK	65mm Open shackle steel lock 6 pin S cylinder	65	31.8	12.7	29	29.5	Special	KB P6	BOX	1	■
SS65S/E1/SD		CEN 5	10	WORK	65mm Open shackle steel lock 6 pin Elite Dimple cylinder	65	31.8	12.7	29	29.5	5012245040531	CYKEY/E1/BL	BOX	1	■
SS65S LEV3	SR3	CEN 5	10	WORK	65mm Open shackle steel lock 6 pin S cylinder	65	31.8	12.7	29	29.5	5012245003994	KB P6	PLATFORM	3	■
SS65S/2.5		CEN 5	10	WORK	65mm 2.5" Long shackle steel lock 6 pin S cylinder	65	31.8	12.7	65	29.5	Special	KB P6	BOX	1	■
SS65S/2.5/E1/SD		CEN 5	10	WORK	65mm 2.5" Long shackle steel lock 6 pin Elite Dimple cylinder	65	31.8	12.7	65	29.5	5012245040555	CYKEY/E1/BL	BOX	1	■
SS65S/F/SHACKLE		CEN 5	10	WORK	65mm Open Flying shackle lock 6 pin S cylinder	65	31.8	12.7	29	29.5	Special	KB P6	BOX	1	■
SS65CSKA		CEN 6	10	WORK	65mm KA Closed shackle steel lock 6 pin S cylinder	65	31.8	12.7	19	19	Special	KB P6	BOX	1	
SS65CS/E1/KA		CEN 6	10	WORK	65mm KA Closed shackle steel lock 6 pin Elite Dimple cylinder	65	31.8	12.7	19	19	Special	CYKEY/E1/BL	BOX	1	
SS65SKA		CEN 5	10	WORK	65mm KA Open shackle steel lock 6 pin S cylinder	65	31.8	12.7	29	29.5	Special	KB P6	BOX	1	
SS65S/E1/KA		CEN 5	10	WORK	65mm KA Open shackle steel lock 6 pin Elite Dimple cylinder	65	31.8	12.7	29	29.5	Special	CYKEY/E1/BL	BOX	1	
SS65S/2.5KA		CEN 5	10	WORK	65mm KA 2.5" Long shackle steel lock 6 pin S cylinder	65	31.8	12.7	65	29.5	Special	KB P6	BOX	1	
SS65S/2.5/E1/KA		CEN 5	10	WORK	65mm KA 2.5" Long shackle steel lock 6 pin Elite Dimple cylinder	65	31.8	12.7	65	29.5	Special	CYKEY/E1/BL	BOX	1	

Restricted profile available
MK denotes master keyed available

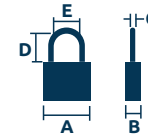

Stronghold® SS50 range - 50mm wide body



Code	LPCB	CEN	Security Rating	@	Description	Dimensions mm					Barcode	Key Blank	Pack Type	Min Qty	MK
						A	B	C	D	E					
SS50CS	SR2	CEN 4	9	WORK	50mm Closed shackle steel lock 6 pin S cylinder	50	26	10	16	16	5012245003413	KB P6	PLATFORM	4	■
SS50CS BOXED	SR2	CEN 4	9	WORK	50mm Closed shackle steel lock 6 pin S cylinder	50	26	10	16	16	Special	KB P6	BOX	1	■
SS50CS/E1/SD		CEN 4	9	WORK	50mm Closed shackle steel lock 6 pin Elite Dimple cylinder	50	26	10	16	16	5012245040517	CYKEY/E1/BL	BOX	1	■
SS50S	SR2	CEN 4	9	WORK	50mm Open shackle steel lock 6 pin S cylinder	50	26	10	26	22	5012245003420	KB P6	PLATFORM	4	■
SS50S BOXED	SR2	CEN 4	9	WORK	50mm Open shackle steel lock 6 pin S cylinder	50	26	10	26	22	Special	KB P6	BOX	1	■
SS50S/E1/SD		CEN 4	9	WORK	50mm Open shackle steel lock 6 pin Elite Dimple cylinder	50	26	10	26	22	5012245040500	CYKEY/E1/BL	BOX	1	■
SS50S 8mm		CEN 3	8	WORK	8mm shackle/50mm Open shackle steel lock 6 pin S cylinder	50	26	8	26	24	Special	KB P6	BOX	1	■
SS50S/2.5		CEN 4	9	WORK	50mm 2.5" Long shackle steel lock 6 pin S cylinder	50	26	10	65	22	5012245006049	KB P6	PLATFORM	4	■
SS50S/2.5/E1/SD		CEN 4	9	WORK	50mm 2.5" Long shackle steel lock 6 pin Elite Dimple cylinder	50	26	10	65	22	5012245040524	CYKEY/E1/BL	BOX	1	■
SS50CP5		CEN 3	8	WORK	50mm Closed shackle steel lock P5 (5 pin) cylinder	50	26	10	16	16	5012245007763	KB P5	PLATFORM	4	■
SS50CP5 BOXED		CEN 3	8	WORK	50mm Closed shackle steel lock P5 (5 pin) cylinder	50	26	10	16	16	Special	KB P6	BOX	4	■
SS50P5		CEN 3	8	WORK	50mm Open shackle steel lock P5 (5 pin) cylinder	50	26	10	26	22	5012245007756	KB P5	PLATFORM	4	■
SS50P5 BOXED		CEN 3	8	WORK	50mm Open shackle steel lock P5 (5 pin) cylinder	50	26	10	26	22	Special	KB P6	BOX	1	■
SS50P5/2.5		CEN 3	8	WORK	50mm 2.5" Long shackle steel lock P5 (5 pin) cylinder	50	26	10	65	22	5012245009996	KB P5	PLATFORM	4	■
SS50CSKA	SR2	CEN 4	9	WORK	50mm KA Closed shackle steel lock 6 pin S cylinder	50	26	10	16	16	Special	KB P6	BOX	1	
SS50CS/E1/KA		CEN 4	9	WORK	50mm KA Closed shackle steel lock 6 pin Elite Dimple cylinder	50	26	10	16	16	Special	CYKEY/E1/BL	BOX	1	
SS50SKA	SR2	CEN 4	9	WORK	50mm KA Open shackle steel lock 6 pin S cylinder	50	26	10	26	22	Special	KB P6	BOX	1	
SS50S/E1/KA		CEN 4	9	WORK	50mm KA Open shackle steel lock 6 pin Elite Dimple cylinder	50	26	10	26	22	Special	CYKEY/E1/BL	BOX	1	
SS50S 8mm KA		CEN 3	8	WORK	8mm shackle/50mm KA Open shackle steel lock 6 pin S cylinder	50	26	8	26	24	Special	KB P6	BOX	1	
SS50S/2.5KA		CEN 4	9	WORK	50mm KA 2.5" Long shackle steel lock 6 pin S cylinder	50	26	10	65	22	Special	KB P6	BOX	1	
SS50S/2.5/E1/KA		CEN 4	9	WORK	50mm KA 2.5" Long shackle steel lock 6 pin Elite Dimple cylinder	50	26	10	65	22	Special	CYKEY/E1/BL	BOX	1	
SS50CP5KA		CEN 3	8	WORK	50mm KA Closed shackle steel lock P5 (5 pin) cylinder	50	26	10	16	16	Special	KB P5	BOX	1	
SS50P5KA		CEN 3	8	WORK	50mm KA Open shackle steel lock P5 (5 pin) cylinder	50	26	10	26	22	Special	KB P5	BOX	1	
SS50P5/2.5KA		CEN 3	8	WORK	50mm KA 2.5" Long shackle steel lock P5 (5 pin) cylinder	50	26	10	65	22	Special	KB P5	BOX	1	

Restricted profile available
MK denotes master keyed available

WORK

Stronghold® Range

MADE IN
BRITAIN

25TH
ANNIVERSARY
STRONGHOLD

10
YEAR
GUARANTEE





new

Stronghold® SS45 - 45mm wide body

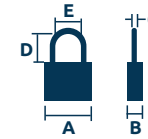

Code	CEN	Security Rating	@	Description	Dimensions mm					Barcode	Key Blank	Pack Type	Min Qty	MK
					A	B	C	D	E					
SS45		7	WORK	45mm open shackle steel lock 6 pin S cylinder	45	25	6	35.5	20	5012245008494	KB P6	BOX	1	■
SS45KA		7	WORK	45mm open shackle steel lock 6 pin S cylinder keyed alike	45	25	6	35.5	20	5012245008739	KB P6	BOX	1	

6mm shackle

SS45S

Restricted profile available
MK denotes master keyed available

Stronghold® SS50 Marine range - 50mm wide body



SS50S
MARINE

SS50CS
MARINE



SS50S/2.5
MARINE

Code	CEN	Security Rating	@	Description	A	B	C	D	E	Barcode	Key Blank	Pack Type	Min Qty	MK
SS50CS/MARINE	CEN 3	8	WORK	50mm Closed Stainless steel shackle lock 6 pin (S) cylinder	50	26	10	16	16	Special	KB P6	BOX	1	■
SS50S/MARINE	CEN 3	8	WORK	50mm Open Stainless steel shackle lock 6 pin (S) cylinder	50	26	10	26	22	Special	KB P6	BOX	1	■
SS50S/2.5/MARINE	CEN 3	8	WORK	50mm Long Stainless steel shackle lock 6 pin (S) cylinder	50	26	10	65	22	Special	KB P6	BOX	1	■
SS50CP5/MARINE	CEN 3	8	WORK	50mm Closed Stainless steel shackle lock 5 pin (P5) cylinder	50	26	10	16	16	Special	KB P5	BOX	1	■
SS50P5/MARINE	CEN 3	8	WORK	50mm Open Stainless steel shackle lock 5 pin (P5) cylinder	50	26	10	26	22	Special	KB P5	BOX	1	■
SS50P5/2.5/MARINE	CEN 3	8	WORK	50mm Long Stainless steel shackle lock 5 pin (P5) cylinder	50	26	10	65	22	Special	KB P5	BOX	1	■
SS50CS/MARINE/KA	CEN 3	8	WORK	50mm Closed Stainless steel shackle lock 6 pin (S) keyed alike cylinder	50	26	10	16	16	Special	KB P6	BOX	1	
SS50S/MARINE/KA	CEN 3	8	WORK	50mm Open Stainless steel shackle lock 6 pin (S) keyed alike cylinder	50	26	10	26	22	Special	KB P6	BOX	1	
SS50S/2.5/MARINE/KA	CEN 3	8	WORK	50mm Long Stainless steel shackle lock 6 pin (S) keyed alike cylinder	50	26	10	65	22	Special	KB P6	BOX	1	
SS50CP5/MARINE/KA	CEN 3	8	WORK	50mm Closed Stainless steel shackle lock 5 pin (P5) keyed alike cylinder	50	26	10	16	16	Special	KB P5	BOX	1	
SS50P5/MARINE/KA	CEN 3	8	WORK	50mm Open Stainless steel shackle lock 5 pin (P5) keyed alike cylinder	50	26	10	26	22	Special	KB P5	BOX	1	
SS50P5/2.5/MARINE/KA	CEN 3	8	WORK	50mm Long Stainless steel shackle lock 5 pin (P5) keyed alike cylinder	50	26	10	65	22	Special	KB P5	BOX	1	

Restricted profile available
MK denotes master keyed available



Rustproof shackle



Marine

Stronghold® integration with high security lock cylinders

Create keyed alike and master keyed suites using a range of cylinder types and profiles

Create keyed alike and master keyed suites using a range of cylinder types and profiles.

Bringing locksmiths absolute flexibility when deciding what level of security your clients need.

Stronghold® padlocks easily accept Euro profile, Scandinavian oval cylinders, Elite dimple pin, **Stronghold®** Protected and Restricted cylinders.



Stronghold® protected range

The Squire **Stronghold®** protected profile provides the answer to the ever-increasing awareness of protected systems. Guarantees that a copy of the key can never be cut unless authorised by the user.

- High quality 6 pin locking system with nickel silver pins
- 530,000 keying differs
- Security key card protected, complete control over key blanks
- Picking protected
- Drill protection in cylinder body with 1 tungsten carbide pin
- Drill protection in core with 3 tungsten carbide pins
- Protection against pulling
- High wear resistance
- Supplied with 2 nickel silver keys
- Can be supplied master keyed or keyed alike

Cylinder Type	Padlock Type
STRONGHOLD - Protected	SS100
	SS80, 65, 50, 45, WS75
STRONGHOLD - Restricted	SS100
	SS80, 65, 50, 45, WS75
STRONGHOLD - Elite 1	SS80, 65, 50, 45, WS75

Master Keyed and Keyed Alike available to special order. Please ask for pricing and delivery details.



Stronghold® restricted range

The Squire Stronghold® restricted profile provides you with a secure method of controlling the copying of your cut keys. Capable of coping with large master key systems and the high usage demands put on the individual cylinder. It can also provide locksmiths with the luxury of their own profile.

- High quality 6 pin locking system with nickel silver pins
- 530,000 keying differs
- Restricted multiple profiles - security key card protected
- Picking protected
- Drill protection in cylinder body with 1 tungsten carbide pin
- Drill protection in core with 3 tungsten carbide pins
- Protection against pulling
- Nickel plated core (nickel finish cylinders only)
- High wear resistance
- Supplied with 2 nickel silver keys
- Can be supplied master keyed or keyed alike
- The system is protected by a security card which must be produced in order to have a copy key cut

Now available as standard
at no extra cost



Stronghold® Elite 1™ cylinder range Dimple pin key system

The Squire Stronghold® Elite 1™ is now available on all Stronghold® padlocks, except for the SS100 range, at the same cost as the conventional sawtooth system.

- High quality 6 pin locking system with nickel plated pins
- 470,000 keying differs
- Picking protected
- Drill protection in cylinder body with 1 tungsten carbide pin
- Drill protection in core with 3 tungsten carbide pins
- Protection against pulling
- Nickel plated core
- High wear resistance
- Supplied with 2 nickel silver Squire keys
- Can be supplied master keyed or keyed alike
- Key blanks are available
- Keys can be cut on all laser and dimple key cutting machines

Stronghold® padlocks - WS75

Stronghold® WS75 container lock

Features

12mm hardened boron alloy steel shackle

80mm solid hardened steel lock body

Electrophoretic finish - anti-corrosion resistance

Rekeyable 6 pin tumbler lock mechanism - over 260,000 key differs

Anti-bump, anti-pick, highly attack resistant

Key section can be upgraded to restricted or protected profile offering over 530,000 key differs

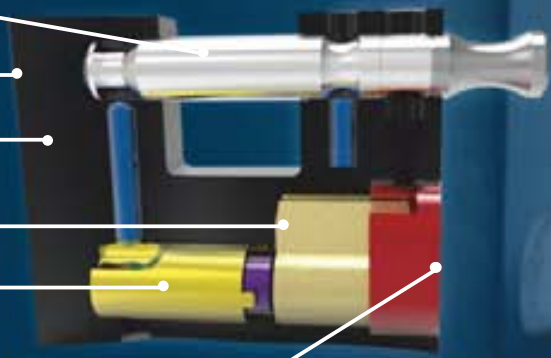

Stronghold® WS75

Code	CEN	Security Rating	@	Description	Dimensions mm						Barcode	Key Blank	Pack Type	Min Qty	MK
					A	B	C	D	E	F					
WS75S	CEN 4	9	WORK	Container lock 6 pin S cylinder	80	26	12	14	27	65	5012245029666	KB P6	PLATFORM	1	■
WS75 BOXED	CEN 4	9	WORK	Container lock 6 pin S cylinder	80	26	12	14	27	65	Special	KB P6	BOX	1	
WS75S/E1/SD	CEN 4	9	WORK	Container lock 6 pin Elite Dimple cylinder	80	26	12	14	27	65	5012245040425	CYKEY/E1/BL	BOX	1	■
WS75SKA	CEN 4	9	WORK	KA Container lock 6 pin S cylinder	80	26	12	14	27	65	Special	KB P6	BOX	1	
WS75S/E1/KA	CEN 4	9	WORK	KA Container lock 6 pin Elite Dimple cylinder	80	26	12	14	27	65	Special	CYKEY/E1/BL	BOX	1	

Restricted profile available
MK denotes master keyed available



Stronghold® Combination Range

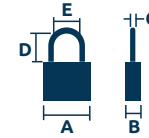

Stronghold® SS50 and SS50CS Combi

Code	Security Rating	@	Description	Dimensions mm					Barcode	Number of Combinations	Pack Type	Min Qty
				A	B	C	D	E				
SS50C/COMBI	8	WORK	5 Wheel C/S Combi Hardened steel c/w weather cover	55	30	10	14	16	5012245028706	100,000	PLATFORM	2
SS50C/COMBI BOXED	8	WORK	5 Wheel C/S Combi Hardened steel c/w weather cover	55	30	10	14	16	Special	100,000	BOX	1
SS50C/COMBI MARINE	7	WORK	Combi Hardened steel Body c/w weather cover - Stainless Steel Close Shackle	55	30	10	14	16	Special	100,000	BOX	1
SS50/COMBI	8	WORK	5 Wheel O/S Combi Hardened steel c/w weather cover	55	30	10	24	22	5012245028690	100,000	PLATFORM	2
SS50/COMBI BOXED	8	WORK	5 Wheel O/S Combi Hardened steel c/w weather cover	55	30	10	24	22	Special	100,000	BOX	1
SS50/COMBI MARINE	7	WORK	Combi Hardened steel Body c/w weather cover - Stainless Steel Open Shackle	55	30	10	24	22	Special	100,000	BOX	1
SS50/2.5/COMBI	8	WORK	5 Wheel Long Shackle Combi Hardened steel c/w weather cover	55	30	10	64	22	Special	100,000	BOX	1
SS50/2.5/COMBI MARINE	7	WORK	Combi Hardened steel Body c/w weather cover - Stainless Steel Long Shackle	55	30	10	64	22	Special	100,000	BOX	1



SHCB High Security Recodable Padlocks

Code	Security Rating	@	Description	A	B	C	D	E	Barcode	Number of Combinations	Pack Type	Min Qty
SHCB65	6	WORK	65mm Combination Block Lock 4 wheel	65	19	11	15	20	5012245009026	10,000	PLATFORM	4
SHCB65 BX	6	WORK	65mm Combination Block Lock 4 wheel - Boxed	65	19	11	15	20	Special	10,000	BOX	1
SHCB75	7	WORK	75mm Combination Block Lock 5 wheel	75	19	12.7	15	20	5012245009033	100,000	PLATFORM	4
CBW85	7	WORK	85mm Wide Clearance Combination Block Lock 5 wheel	85	19	12.7	17	37	5012245008654	100,000	PLATFORM	4
CBW85 BX	7	WORK	85mm Wide Clearance Combination Block Lock 5 wheel - Boxed	85	19	12.7	17	37	Special	100,000	BOX	1
SHCB65/Chain	6	WORK	65mm 4 wheel combi c/w chain attachment (2.4mm x 305mm)	65	19	11	15	20	Special	10,000	BOX	1
SHCB75/Chain	7	WORK	75mm 5 wheel combi c/w chain attachment (2.4mm x 305mm)	75	19	12.7	15	20	Special	100,000	BOX	1
CBW85/Chain	7	WORK	Wide Clearance 5 wheel combi, chain attached (2.4mm x 305mm)	85	19	12.7	17	37	Special	100,000	BOX	1



Stronghold® Security fittings - CEN Grade



Code	CEN	LPCB	Security Rating	@	Description	Dimensions mm					Barcode	Key Blank	Pack Type	Min Qty
						A	B	C	Staple Clearance	Bolt Dia				
STH100	CEN 6	SR4*	10	WORK	Hardened Stronghold Padbar - CEN 6 for SS100CS only	184	86	32	n/a	18	5012245038828	n/a	BOX	1
STH1	CEN 6		10	WORK	Hardened Stronghold Padbar - CEN 6	184	86	32	16	18	5012245007770	n/a	BOX	1
STH3	CEN 4		9	WORK	Extra High Security hardened steel Hasp & Staple - CEN 4	231	76	52.5	13	18	5012245038064	n/a	PLATFORM	1

*Please note that the STH100 is only rated LPCB SR4 when used in combination with an SS100CS padlock

Products for locksmiths

Stronghold® **NEW**
Half Euro padlocks

Accepts a Half Euro cylinder with no modification

- Create your own suite of padlocks using adjustable cam 45mm Half Euro cylinders
- Cylinders need no extra modifications
- Quick and easy process
- Very high specification locks using Squire's **Stronghold®** range of CEN grade locks*. No compromise on quality
- Two body widths available, 65mm and 55mm, in open shackle and long shackle variants
- Electrochromic finish for anti-corrosion resistance



SS65HE



SS55HE

Stronghold® Half Euro padlock range

Code	CEN	Security Rating	@	Description	Dimensions mm					Barcode	Pack Type	Min Qty
					A	B	C	D	E			
SS65HE	CEN 5	10	WORK	65mm open shackle steel lock accepts Half Euro cylinder	65	32	12.7	29	29	5012245037630	BOX	1
SS65S/2.5HE	CEN 5	10	WORK	65mm 2.5" long shackle steel lock accepts Half Euro cylinder	65	32	12.7	65	29	Special	BOX	1
SS55SHE	CEN 3	9	WORK	55mm open shackle steel lock accepts Half Euro cylinder	55	25	10	26	22	5012245037623	BOX	1
SS55S/2.5HE	CEN 3	9	WORK	55mm 2.5" long shackle steel lock accepts Half Euro cylinder	55	25	10	64	22	Special	BOX	1

Stronghold® **NEW**
Scandinavian oval padlocks

Accepts a Scandinavian oval cylinder with no modification

- Create your own suite of padlocks using Scandinavian oval cylinders
- Padlocks need no extra modifications.
- Quick and easy process
- Very high specification locks using Squire's **Stronghold®** range of CEN grade locks*. No compromise on quality
- Three body widths available, 80mm, 65mm and 50mm, in open shackle and long shackle variants
- For scan oval padlock with Tang add FCAM to product code, or scan oval padlock with slot add MCAM to product code
- Electrochromic finish for anti-corrosion resistance

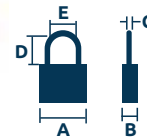

Stronghold®
Euro profile padlocks

Original SS65E and SS50EM ranges
The **original** Squire Euro profile range - accepts a Half Euro cylinder **with** modification



The Europrofile 'E' and 'EM' ranges are the original Squire locks designed for fitment of a modified 71mm double Europrofile cylinder. The 'E' Range for 65mm padlocks and the 'EM' Range for 50mm padlocks differ in that the module used to hold the Euro profile cylinder is slightly different.

- Create your own suite of padlocks using modified Euro cylinders
- Can use same modified cylinder in SS50EM, SS50CEM, SS65E, SS65CE padlocks
- Integrate **Stronghold®** padlocks with any existing key system
- Supplied body only
- No need to drill into modified cylinder
- Electrochromic finish for anti-corrosion resistance



*Padlock CEN grade applies to padlock on its own. Your Half Euro cylinder will affect this rating.

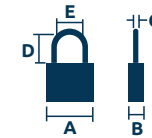

Solid Steel - Euro Versions - body only - accepts modified half Euro



'E' and 'EM' Versions

Code	CEN	Security Rating	@	Description	Dimensions mm					Barcode	Pack Type	Min Qty
					A	B	C	D	E			
SS65CE	CEN 6	10	WORK	65mm Euro Body C/S - Accepts 1/2 modified 71 Double Euro	65	31.8	12.7	19	19	5012245005073	BOX	1
SS65E	CEN 5	10	WORK	65mm Euro Body O/S - Accepts 1/2 modified 71 Double Euro	65	31.8	12.7	29	29.5	5012245008494	BOX	1
SS65E/2.5	CEN 5	10	WORK	65mm Euro Body 2.5" L/S - Accepts 1/2 modified 71 Double Euro	65	31.8	12.7	65	29.5	Special	BOX	1
SS50CEM	CEN 4	9	WORK	50mm Euro Body C/S - Accepts 1/2 modified 71 Double Euro	50	26	10	16	16	5012245008746	BOX	1
SS50EM	CEN 4	9	WORK	50mm Euro Body O/S - Accepts 1/2 modified 71 Double Euro	50	26	10	26	22	5012245008739	BOX	1
SS50EM/2.5	CEN 4	9	WORK	50mm Euro Body 2.5" L/S - Accepts 1/2 modified 71 Double Euro	50	26	10	65	22	5012245008753	BOX	1
SS50CEM/MARINE	CEN 3	8	WORK	Euro Body Marine C/S - Accepts 1/2 modified 71 Double Euro Stainless Steel Shackle	50	26	10	16	16	Special	BOX	1
SS50EM/MARINE	CEN 3	8	WORK	Euro Body Marine O/S - Accepts 1/2 modified 71 Double Euro Stainless Steel Shackle	50	26	10	26	22	Special	BOX	1

*Padlock CEN grade applies to padlock on its own. Your Half Euro cylinder will affect this rating.

Stronghold® Scandinavian oval padlock range



SS65C/SCAN/MCAM	CEN 6	10	WORK	SS65C padlock B/O to accept Scan Oval with Slot	65	31.8	12.7	19	19	5012245037746	BOX	1
SS65C/SCAN/FCAM	CEN 6	10	WORK	SS65C padlock B/O to accept Scan Oval with Tang	65	31.8	12.7	19	19	5012245037753	BOX	1
SS65/SCAN/MCAM	CEN 5	10	WORK	SS65 padlock B/O to accept Scan Oval with Slot	65	31.8	12.7	29	29	5012245037708	BOX	1
SS65/SCAN/FCAM	CEN 5	10	WORK	SS65 padlock B/O to accept Scan Oval with Tang	65	31.8	12.7	29	29	5012245037715	BOX	1
SS65/2.5/SCAN/MCAM	CEN 5	10	WORK	SS65 2.5 padlock B/O to accept Scan Oval with Slot	65	31.8	12.7	64	29	5012245037722	BOX	1
SS65/2.5/SCAN/FCAM	CEN 5	10	WORK	SS65 2.5 padlock B/O to accept Scan Oval with Tang	65	31.8	12.7	64	29	5012245037739	BOX	1
SS50C/SCAN/MCAM	CEN 4	9	WORK	SS50C padlock B/O to accept Scan Oval with Slot	50	26	10	16	16	5012245037685	BOX	1
SS50C/SCAN/FCAM	CEN 4	9	WORK	SS50C padlock B/O to accept Scan Oval with Tang	50	26	10	16	16	5012245037692	BOX	1
SS50/SCAN/MCAM	CEN 4	9	WORK	SS50 padlock B/O to accept Scan Oval with Slot	50	26	10	26	22	5012245037647	BOX	1
SS50/SCAN/FCAM	CEN 4	9	WORK	SS50 padlock B/O to accept Scan Oval with Tang	50	26	10	26	22	5012245037654	BOX	1
SS50/2.5/SCAN/MCAM	CEN 4	9	WORK	SS50 2.5 padlock B/O to accept Scan Oval with Slot	50	26	10	64	22	5012245037661	BOX	1
SS50/2.5/SCAN/FCAM	CEN 4	9	WORK	SS50 2.5 padlock B/O to accept Scan Oval with Tang	50	26	10	64	22	5012245037678	BOX	1

*Padlock CEN grade applies to padlock on its own. Your Scan Oval cylinder will affect this rating.

A heavy duty, high specification range of combination padlocks.

They don't get much tougher than our new range of heavy duty, high performance Warrior padlocks available in a vast range of body widths and shackle types. The armoured steel body, boron shackle and protective cover make these Warriors hard to beat.

Warrior® Combi Range - Features

Hardened **Boron** steel shackle with Satin Chrome finish

Armoured steel body

45 and 55 versions have 4 Wheels 10,000 combinations

65 versions have 5 wheels 100,000 combinations

Ergonomic designed wheels for ease of use - Fully recodable

Patented



Boron steel shackle

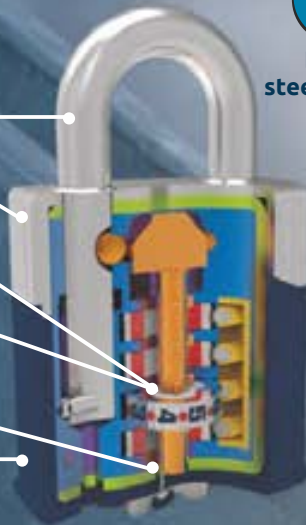



Warrior® Combi Range

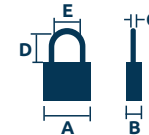

Open Shackle

Code	Security Rating	@	Description	Dimensions mm					Barcode	Number of Combinations	Pack Type	Min Qty
				A	B	C	D	E				
WARRIOR COMBI 65	8	WORK	5 Wheel 65mm Open shackle Combination padlock	65	39	12	30	28	5012245035797	100,000	PLATFORM	4
WARRIOR COMBI 55	7	WORK	4 Wheel 55mm Open shackle Combination padlock	55	32	10	25	23	5012245035827	10,000	PLATFORM	4
WARRIOR COMBI 55 BX	7	WORK	4 Wheel 55mm Open shackle Combination padlock - Boxed	55	32	10	25	23	Special	10,000	BOX	1
WARRIOR COMBI 45	6	WORK	4 Wheel 45mm Open shackle Combination padlock	45	25	8	20	18	5012245035858	10,000	PLATFORM	6
WARRIOR COMBI 45 BX	6	WORK	4 Wheel 45mm Open shackle Combination padlock - Boxed	45	25	8	20	18	Special	10,000	BOX	1

Closed Shackle

WARRIOR COMBI 65CS	9	WORK	5 Wheel 65mm Closed shackle Combination padlock	65	39	12	25	23	5012245035780	100,000	PLATFORM	4
WARRIOR COMBI 55CS	8	WORK	4 Wheel 55mm Closed shackle Combination padlock	55	32	10	19	19	5012245035810	10,000	PLATFORM	6
WARRIOR COMBI 55CS BX	8	WORK	4 Wheel 55mm Closed shackle Combination padlock - Boxed	55	32	10	19	19	Special	10,000	BOX	1
WARRIOR COMBI 45CS	7	WORK	4 Wheel 45mm Closed shackle Combination padlock	45	25	8	15	15	5012245035841	10,000	PLATFORM	6
WARRIOR COMBI 45CS BX	7	WORK	4 Wheel 45mm Closed shackle Combination padlock - Boxed	45	25	8	15	15	Special	10,000	BOX	1

Long Shackle

WARRIOR COMBI 65/2.5	8	WORK	5 Wheel 65mm 2.5" Long shackle Combination padlock	65	39	12	63	28	5012245035803	100,000	PLATFORM	4
WARRIOR COMBI 55/2.5	7	WORK	4 Wheel 55mm 2.5" Long shackle Combination padlock	55	32	10	63	23	5012245035834	10,000	PLATFORM	6
WARRIOR COMBI 45/2.5	6	WORK	4 Wheel 45mm 2.5" Long shackle Combination padlock	45	25	8	63	18	5012245035865	10,000	PLATFORM	6

Warrior® Key Range

A heavy duty, high specification range of key operated padlocks.

These uniquely designed padlocks offer a medium to high level of security. They come in 3 body widths 45mm, 55mm and 65mm and within each size, open shackle, closed shackle and long shackle variants are available. They can be supplied Keyed Alike upon request.



Warrior® Range - Features



chromium manganese steel shackle

Hardened chromium manganese steel

Armoured steel body

5 pin cylinder

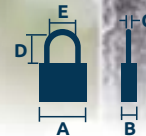
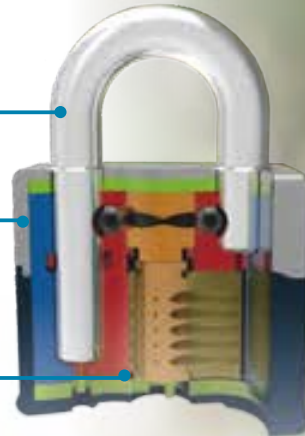

Open Shackle



WAR55



WAR45

Code	CEN	Security Rating	@	Description	Dimensions mm					Barcode	Key Blank	Pack Type	Min Qty
					A	B	C	D	E				
WARRIOR 65 BX	CEN 3	8	WORK	65mm Open shackle steel padlock 5 pin cylinder - Boxed	65	34	12	30	24	Special	KB P5	BOX	1
WARRIOR 55	CEN 3	7	WORK	55mm Open shackle steel padlock 5 pin cylinder	55	34	10	30	24	5012245035735	KB P5	PLATFORM	6
WARRIOR 55 BX	CEN 3	7	WORK	55mm Open shackle steel padlock 5 pin cylinder - Boxed	55	34	10	30	24	Special	KB P5	BOX	1
WARRIOR 45	CEN 2	6	WORK	45mm Open shackle steel padlock 5 pin cylinder	45	26	8	20	20	5012245035766	KB P5	PLATFORM	6
WARRIOR 45 BX	CEN 2	6	WORK	45mm Open shackle steel padlock 5 pin cylinder - Boxed	45	26	8	20	20	Special	KB P5	BOX	1
WARRIOR 65 KA	CEN 3	8	WORK	65mm KA Open shackle steel padlock 5 pin cylinder	65	34	12	30	24	Special	KB P5	BOX	1
WARRIOR 55 KA	CEN 3	7	WORK	55mm KA Open shackle steel padlock 5 pin cylinder	55	34	10	30	24	Special	KB P5	BOX	1
WARRIOR 45 KA	CEN 2	6	WORK	45mm KA Open shackle steel padlock 5 pin cylinder	45	26	8	20	20	Special	KB P5	BOX	1



Warrior® Key Range

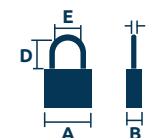

Closed Shackle



WAR65CS WAR55CS



WAR45CS



WAR65/2.5 WAR55/2.5



WAR45/2.5

Code	CEN	Security Rating	@	Description	Dimensions mm					Barcode	Key Blank	Pack Type	Min Qty
					A	B	C	D	E				
WARRIOR 65C	CEN 3	9	WORK	65mm Closed shackle steel padlock 5 pin cylinder	65	34	12	27	16	5012245035698	KB P5	PLATFORM	4
WARRIOR 65C BX	CEN 3	9	WORK	65mm Closed shackle steel padlock 5 pin cylinder - Boxed	65	34	12	27	16	Special	KB P5	BOX	1
WARRIOR 55C	CEN 3	8	WORK	55mm Closed shackle steel padlock 5 pin cylinder	55	34	10	17	15	5012245035728	KB P5	PLATFORM	6
WARRIOR 55C BX	CEN 3	8	WORK	55mm Closed shackle steel padlock 5 pin cylinder - Boxed	55	34	10	17	15	Special	KB P5	BOX	1
WARRIOR 45C	CEN 2	7	WORK	45mm Closed shackle steel padlock 5 pin cylinder	45	26	8	18	15	5012245035759	KB P5	PLATFORM	6
WARRIOR 45C BX	CEN 2	7	WORK	45mm Closed shackle steel padlock 5 pin cylinder - Boxed	45	26	8	18	15	Special	KB P5	BOX	1
WARRIOR 65C KA	CEN 3	9	WORK	65mm KA Closed shackle steel padlock 5 pin cylinder	65	34	12	27	16	Special	KB P5	BOX	1
WARRIOR 55C KA	CEN 3	8	WORK	55mm KA Closed shackle steel padlock 5 pin cylinder	55	34	10	17	15	Special	KB P5	BOX	1
WARRIOR 45C KA	CEN 2	7	WORK	45mm KA Closed shackle steel padlock 5 pin cylinder	45	26	8	18	15	Special	KB P5	BOX	1

Long Shackle

WAR65/2.5	CEN 3	8	WORK	65mm 2.5" Long shackle steel padlock 5 pin cylinder	65	34	12	63	24	5012245035711	KB P5	PLATFORM	4
WAR45/2.5	CEN 2	6	WORK	45mm 2.5" Long shackle steel padlock 5 pin cylinder	45	26	8	63	20	5012245035773	KB P5	PLATFORM	6
WAR65/2.5 KA	CEN 3	8	WORK	65mm KA 2.5" Long shackle steel padlock 5 pin cylinder	65	34	12	63	24	Special	KB P5	BOX	1
WAR55/2.5 KA	CEN 3	7	WORK	55mm KA 2.5" Long shackle steel padlock 5 pin cylinder	55	34	10	63	24	Special	KB P5	BOX	1
WAR45/2.5 KA	CEN 2	6	WORK	45mm KA 2.5" Long shackle steel padlock 5 pin cylinder	45	26	8	63	20	Special	KB P5	BOX	1

General Use Padlocks

Warehouse Lock Range

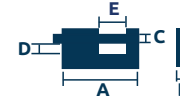

ASWL1 ASWL2

Code	Security Rating	@	Description	Dimensions mm					Barcode	Key Blank	Pack Type	Min Qty
				A	B	C	D	E				
ASWL1	6	WORK	60mm Armoured Brass Block Lock (Small) 5 pin	60	25	10	12	22	5012245004250	KB P5	PLATFORM	6
ASWL2	7	WORK	80mm Armoured Brass Block Lock (Large) 5 pin	80	30	11	15	29	5012245004267	KB P5	PLATFORM	6
ASWL1KA	6	WORK	60mm KA Armoured Brass Block Lock (Small) 5 pin	60	25	10	12	22	Special	KB P5	BOX	1
ASWL2KA	7	WORK	80mm KA Armoured Brass Block Lock (Large) 5 pin	80	30	11	15	29	Special	KB P5	BOX	1



DCL1 DCL1 COMBI

DCL Range

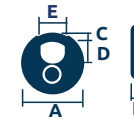

Key Blank or
No of combinations

Code	Security Rating	@	Description	Dimensions mm					Barcode	Key Blank or No of combinations	Pack Type	Min Qty
				A	B	C	D	E				
DCL1	7	WORK	70mm Disc style padlock 5 pin - anti-drill	70	27.5	9.5	17.5	17	5012245003666	KB P5	PLATFORM	6
DCL1KA	7	WORK	KA Disc style padlock 5 pin - anti-drill	70	27.5	9.5	17.5	17	Special	KB P5	BOX	1
DCL1 COMBI	6	WORK	70mm Disc style combination padlock	70	22	8.5	18.5	23	5012245014105	10,000	PLATFORM	6

Lock Off



Code	Security Rating	@	Description	Dimensions mm			Shackle Clearance	Barcode	Pack Type	Min Qty
				A	B	C				
L4	N/A	WORK	Lock Off - 6 hole	42	120	9	10	5012245021165	BOX	1





Combi-Bolt® 5

Unique recodable locking bolt

5 Wheels - 100,000 Combinations

- Die cast lock body
- Steel bolt
- Recodable CombiBolt5 has 5 wheels giving 100,000 combinations
- No Keys to Lose
- One handed operation
- Security screws included in pack
- High pick resistance
- Patented
- Replaces a padlock and hasp & staple

Uses

Sheds, cupboards, storage areas, cabinets, lockers

New Combi-Bolt® POS board

The **Combi-Bolt®** range is a highly popular and successful group of products. All 5 versions of the **Combi-Bolt®** are displayed on the Point of sale board. The board is made from lightweight di-bond and comes with hanging brackets affixed for easy installation. All **Combi-Bolts®** are pre-fixed to the board with security head screws.

Combi-Bolt5®

Patented combination locking bolt



Can be coded alike



No keys to lose



Rustproof



All Weather



Code	Security Rating	@	Description	Dimensions mm			Barcode	Number of Combinations	Pack Type	Min Qty
				A	B	C				
COMBI5	5	WORK	150mm Combination Bolt blue die cast recodable	150	60	40	5012245035551	100,000	PLATFORM	2

Hasp and Staples



NEW - STH100 Extra high security padbar

The new STH100 has been designed to be used only with the new SS100CS padlock. When used together these two very high specification products achieve LPCB Level 4.

The padbar body is made from a special hardened cast material and the hardened staple rotates for extra security making it more resistant to attack.

The STH100 is easy to fit and offers more protection than a normal hasp and staple.



Certified to
LPS 1654: Issue 1
Security Rating 4
Cert. No. 1179b/01



Grade 6

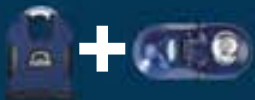

Hasp and Staples



STH100 Padbar

- High security padbar with hardened hasp and staple
- Special hardened cast material - extremely strong
- Hardened rotating staple for extra resistance to attack
- For use only with the SS100CS Padlock
- LPCB Level 4 when used together



STH1 Padbar

- High security padbar with hardened hasp and staple.
- Special hardened cast material - extremely strong.
- Easy to fit.
- Hardened rotating staple for extra resistance to attack



STH3

- Hardened steel construction with anti-corrosion finish
- Hardened steel staple
- Nut and bolt fixing for added security
- Concealed fixings
- Sold Secure Security Padlock Fittings Silver
- Meets new building regulation requirement for out-buildings security



No.8

- Hardened hasp and staple
- Hardened steel construction with anti-corrosion finish
- Coach bolt fixings for added security
- Concealed fixings
- Can be used on single or double doors



STH100



STH1



Stronghold® CEN Rated Padbars



Code	CEN	LPCB	Security Rating	@	Description	Dimensions mm			Staple Clearance	Fixing bolt diameter	Barcode	Pack Type	Min Qty
						A	B	C					
STH100	6	SR4*	10	WORK	Hardened Stronghold Padbar - CEN 6 for SS100CS only	184	86	32	n/a	18	5012245038828	BOX	1
STH1	6		10	WORK	Hardened Stronghold Padbar - CEN 6	184	86	32	16	18	5012245007770	BOX	1

* LPCB Level 4 only when used in combination with a SS100CS padlock



STH3



NO.8



Hasp and Staples



Code	CEN	Security Rating	@	Description	Dimensions mm				Barcode	Pack Type	Min Qty
					A	B	C	Staple Clearance			
STH3	4	9	WORK	Extra High Security hardened steel Hasp & Staple - CEN 4	231	76	52.5	13	5012245038064	PLATFORM	1
NO.8		7	WORK	Hardened Hasp & Staple	216	54.2	38	25	5012245003284	PLATFORM	2

High Security Hardened Alloy Steel Chains - Sold Secure Approved - Lock And Chain Sets



SS100CS/TC22



SS80CS/TC22



SS80CS/TC19



SS80CS/TC16



SS65CS/TC14



SS50CS/TC14



SS50CS/G4



DCL1/J3



SS50S/G4

Lock and Chain Sets

High Security Hardened Alloy Steel Chains - Sold Secure Approved - Lock And Chain Sets

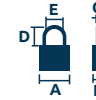

Code	Security Rating	Sold Secure	Description	Link Diameter	Chain Length	Dimensions mm					Barcode	Key Blank	Pack Type	Min Qty	MK
						A	B	C	D	E					
SS100CS/TC22/5	10	Motorcycle	SS100CS padlock with hardened alloy chain	22	1500	100	62	20	33	28	5012245038835	KB P6	TAG	1	■
SS80CS/TC22/5	10	Motorcycle	SS80CS padlock with hardened alloy chain	22	1500	80	40	16	25	24	5012245038842	KB P6	TAG	1	■
SS80CS/TC19/5	10	Motorcycle	SS80CS padlock with hardened alloy chain	19	1500	80	40	16	25	24	5012245038859	KB P6	TAG	1	■
SS80CS/TC16/5	10	Motorcycle	SS80CS padlock with hardened alloy chain	16	1500	80	40	16	25	24	5012245038866	KB P6	TAG	1	■
SS65CS/TC14/3	10	Motorcycle	SS65CS padlock with hardened alloy chain	14	915	65	31.8	12.7	19	19	5012245029215	KB P6	TAG	1	■
SS65CS/TC14/4	10	Motorcycle	SS65CS padlock with hardened alloy chain	14	1200	65	31.8	12.7	19	19	5012245022346	KB P6	TAG	1	■
SS50CS/TC14/3	10	Motorcycle	SS50CS padlock with hardened alloy chain	14	915	50	26	10	16	16	5012245029222	KB P6	TAG	1	■
SS50CS/TC14/4	10	Motorcycle	SS50CS padlock with hardened alloy chain	14	1200	50	26	10	16	16	5012245029239	KB P6	TAG	1	■
SS50CS/G4	9	Bicycle	SS50CS padlock with hardened alloy chain	10	1200	50	26	10	16	16	5012245004045	KB P6	TAG	1	■
DCL1/J3	9	Bicycle	DCL1 Padlock with hardened alloy chain	8	915	70	27.5	9.5	17.5	17	5012245020106	KB P6	TAG	6	■
SS50S/G3	8	Bicycle	SS50S Padlock with hardened alloy chain	10	915	50	26	10	26	22	5012245003536	KB P6	TAG	1	■

Keyed Alike available
MK Refers to master keyed available



High Security **Hardened Alloy Steel** Chains - Sold Secure Approved



Stronghold®
TC22
Diameter - 22mm
Length - 1500mm
Hardened Alloy Steel



Stronghold®
TC19
Diameter - 19mm
Length - 1500mm
Hardened Alloy Steel



Stronghold®
TC16
Diameter - 16mm
Length - 1500mm
Hardened Alloy Steel



Stronghold®
TC14
Diameter - 14mm
Lengths - 915mm, 1200mm
Hardened Alloy Steel



Stronghold®
G Chain
Diameter - 10mm
Lengths - 915mm, 1200mm
1500mm, 2000mm
Hardened Alloy Steel



Stronghold®
J Chain
Diameter - 8mm
Lengths - 915mm, 1200mm
Hardened Alloy Steel





High Security Hardened Alloy Steel Chains - Sold Secure Approved



Code	Security Rating	Sold Secure	Description	Dimensions mm		Barcode	Pack Type	Min Qty
				Link Diameter	Chain Length			
TC22/5	10	Motorcycle	TC Chain alloy steel hardened chain, blue sleeve	22	1500	5012245038378	TAG	1
TC19/5	10	Motorcycle	TC Chain alloy steel hardened chain, blue sleeve	19	1500	5012245035889	TAG	1
TC16/5	10	Motorcycle	TC Chain alloy steel hardened chain, blue sleeve	16	1500	5012245035896	TAG	1
TC14/3	10	Motorcycle	TC Chain alloy steel hardened chain, blue sleeve	14	915	5012245028089	TAG	1
TC14/4	10	Motorcycle	TC Chain alloy steel hardened chain, blue sleeve	14	1200	5012245028096	TAG	1
G3	9	Bicycle	G Chain alloy steel hardened chain, blue sleeve	10	915	5012245006537	TAG	1
G4	9	Bicycle	G Chain alloy steel hardened chain, blue sleeve	10	1200	5012245003116	TAG	1
G5	9	Bicycle	G Chain alloy steel hardened chain, blue sleeve	10	1500	5012245038590	TAG	1
G7	9	Bicycle	G Chain alloy steel hardened chain, blue sleeve	10	2000	5012245040630	TAG	1
J3	8	Bicycle	J Chain alloy steel hardened chain, blue sleeve	8	915	5012245008630	TAG	1
J4	8	Bicycle	J Chain alloy steel hardened chain, blue sleeve	8	1200	5012245004366	TAG	1





Keykeep™ 2 12 Button Recodable Key Safe With Weatherproof Cover



Product features

- Durable Die cast construction designed to withstand attack
- 12 Button recodable combination lock
- 4000 possible combinations - recodable. Revoke access at any point by changing the code
- Chosen code can be any number of digits, from a one digit code, up to a 12 digit code
- Easy to recode
- Weather resistant cover
- Discrete appearance, dark colour does not attract attention
- Automatic reset feature for extra security
- Internal capacity suitable for holding multiple keys. (85mm x 68mm x 13mm)
- Attaches easily to any flat surface
- Comes with 4 fixing bolts

Dimensions

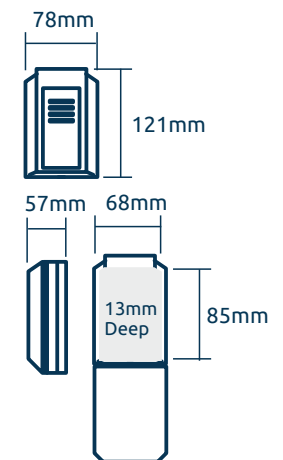

Keykeep™ 1 4 Wheel Combination Key Safe



Product features

- Durable construction
- Four wheel recodable combination lock
- Weather resistant cover
- Easy to fit and recode

Keep a spare key safely outside your property for emergencies

Typical uses

- Keep elderly or infirm relatives' keys for fast access in an emergency
- Easy access for your children when they get home
- Ideal for shed keys, garage keys etc
- Allows gardeners, cleaners, workmen, care workers access to your home
- Allows access to only those who know the code
- Provides a mini-safe for holiday homes, guest houses, B&Bs and rental accommodation
- Ideal for offices or holiday lets
- Keep your spare key safe and secure
- Ideal for external and internal use
- Choose your own secure access code

Important Notes

All key safes and key keeps should be placed out of sight so as not to invite attack. Fix your key safe in a discrete location and only make its location known to those who need access. Check with your insurer that using a key safe does not in any way conflict with the terms and conditions of your insurance policy.

Keykeep™ 1 and Keykeep™ 2 now come in hanging boxes

Squire's commitment to reducing plastic packaging means that these products are no longer available in clam packs. Our new boxes can be hung on a Eurohook



Key Safes



KEYKEEP1



KEYKEEP2

Code	@	Description	Dimensions mm			Barcode	Number of Combinations	Pack Type	Min Qty
			A	B	C				
KEYKEEP1BX	WORK	Combination Key Safe Boxed	85	120	35	5012245022087	10,000	HANGING BOX	2
KEYKEEP2BX	WORK	Push Button Key Safe Boxed	78	121	57	5012245035322	4,000	HANGING BOX	2



HOME

Home category products, as the name suggests, is perfect for home use. It includes general purpose products like our brass, laminated and combination padlocks. It's ideal for gates, toolboxes, cabinets and garage doors. And it includes specialist locks such as our combination bolt, locks & hasps for outside gates or sheds.

Product usage

- All-round home use
- Garage
- Shed
- Front gate
- Storage

Why choose HOME

- Tough all round locks
- Weather-proofed
- Guaranteed 10 years
- Key and combi
- Thief-proof, tested

Security rating

basic 1-4 / high 5-7

Squire HOME brands

- CP Combination
- CP All Terrain
- **Combi-bolt™**
- **Vulcan™** Combi
- **Vulcan™** Key
- **Stronglock™**
- **Lion**
- **Old English**
- Medium duty security hasps
- **Keybolt™**





A mighty robust high security range of combination locks

Named after Vulcan, the ancient Roman god of fire and metalworking, this mighty tough combination padlock range takes some beating. Easy to use in 4 and 5-wheel versions, these Vulcans are fully recodable and offer up to 100,000 combinations.

Vulcan™ Combi Range - Features

Hardened **Boron** steel shackle with Satin Chrome finish

Double locking

Vulcan40 and Vulcan50
4 Wheels 10,000 combinations

Vulcan60 - 5 Wheels
100,000 combinations

Fully recodable

Satin chrome die cast alloy body

Push button opening

New patented design

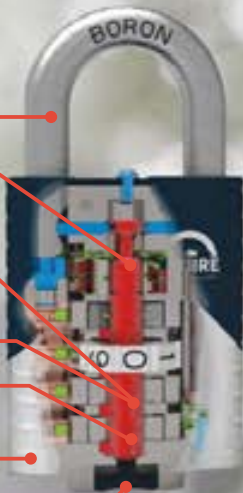

Boron
steel shackle

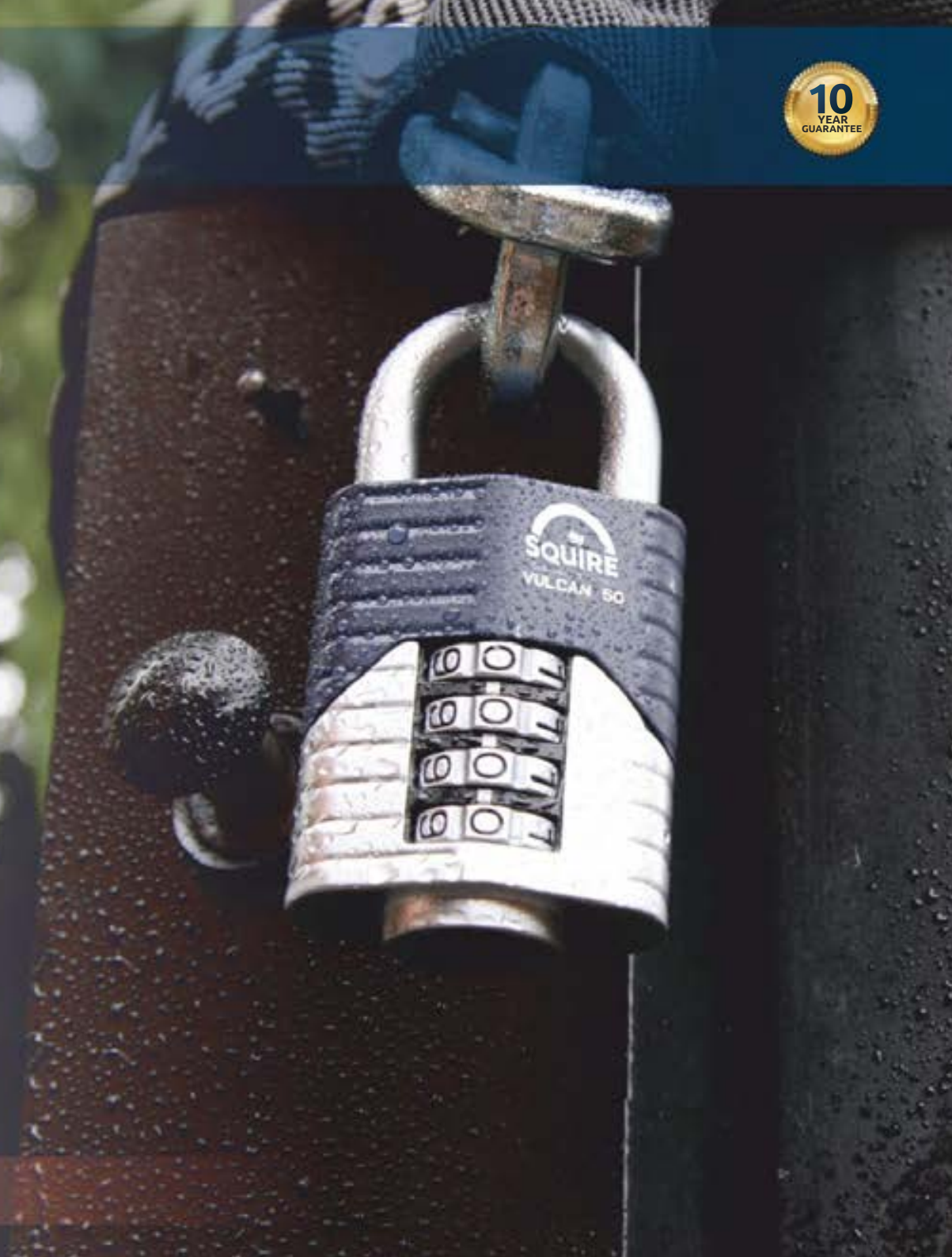

Vulcan™ Combi Range



**Boron
steel shackle**

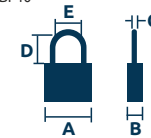

Vulcan™ Combi Range

Open Shackle

Code	Security Rating	@	Description	Dimensions mm					Barcode	Number of Combinations	Pack Type	Min Qty
				A	B	C	D	E				
VULCAN COMBI 60	6	HOME	60mm Combination Padlock - 5 wheel	60	33	10	34	28	5012245035612	100,000	PLATFORM	4
VULCAN COMBI 60BX	6	HOME	60mm Combination Padlock - 5 wheel - Boxed	60	33	10	34	28	Special	100,000	BOX	1
VULCAN COMBI 50	5	HOME	50mm Combination Padlock - 4 wheel	50	26	8	26	22.6	5012245035506	10,000	PLATFORM	6
VULCAN COMBI 50BX	5	HOME	50mm Combination Padlock - 4 wheel - Boxed	50	26	8	26	22.6	Special	10,000	BOX	1
VULCAN COMBI 40	4	HOME	40mm Combination Padlock - 4 wheel	40	22	6	20	17	5012245035643	10,000	PLATFORM	6
VULCAN COMBI 40BX	4	HOME	40mm Combination Padlock - 4 wheel - Boxed	40	22	6	20	17	Special	10,000	BOX	1

Closed Shackle

VULCAN COMBI 60CS	7	HOME	60mm Closed Shackle Combination Padlock - 5 wheel	60	33	10	29	22	5012245035629	100,000	PLATFORM	4
VULCAN COMBI 50CS	6	HOME	50mm Closed Shackle Combination Padlock - 4 wheel	50	26	8	22	15	5012245035520	10,000	PLATFORM	6
VULCAN COMBI 40CS	4	HOME	40mm Closed Shackle Combination Padlock - 4 wheel	40	22	6	17	13	5012245035650	10,000	PLATFORM	6

Long Shackle

VULCAN COMBI 60/2.5	6	HOME	60mm 2.5" Long Shackle Combination Padlock - 5 wheel	60	33	10	63	28	5012245035636	100,000	PLATFORM	4
VULCAN COMBI 50/2.5	5	HOME	50mm 2.5" Long Shackle Combination Padlock - 4 wheel	50	26	8	63	22.6	5012245035513	10,000	PLATFORM	6
VULCAN COMBI 40/2.5	4	HOME	40mm 2.5" Long Shackle Combination Padlock - 4 wheel	40	22	6	63	17	5012245035667	10,000	PLATFORM	6



Vulcan™ Range



A mighty tough range of high performance locks

These uniquely designed key operated padlocks offer a medium to high level of security. They come in 3 body widths 40mm, 45mm and 50mm and within a variety of shackle types. They can be supplied Keyed Alike upon request.

Vulcan™ Range - Features

- Hardened **boron** alloy steel shackle
- Steel body with Die cast satin chrome body cover
- 4 pin tumbler lock mechanism

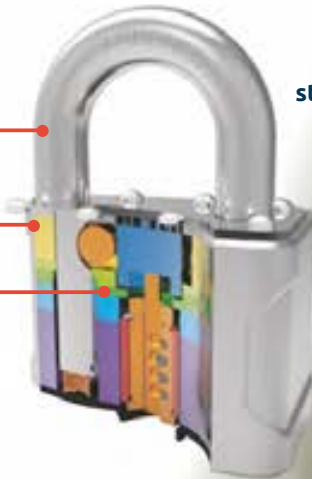

Vulcan™ Key Range

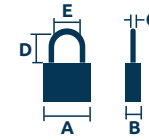

Open Shackle



VULCAN P4 40



VULCAN P4 45



VULCAN P4 50

Code	Security Rating	@	Description	Dimensions mm					Barcode	Key Blank	Pack Type	Min Qty
				A	B	C	D	E				
VULCAN P4 50	6	HOME	50mm Steel Body, Die cast cover with Boron Shackle	55	33	9.5	23.5	22	5012245035469	KB P4	PLATFORM	6
VULCAN P4 50 BX	6	HOME	50mm Steel Body, Die cast cover with Boron Shackle - Boxed	55	33	9.5	23.5	22	Special	KB P4	BOX	1
VULCAN P4 45	5	HOME	45mm Steel Body, Die cast cover with Boron Shackle	48	28	8	19	20.5	5012245035582	KB P4	PLATFORM	6
VULCAN P4 40	5	HOME	40mm Steel Body, Die cast cover with Boron Shackle	44	27	7	18	19	5012245035452	KB P4	PLATFORM	6
VULCAN P4 40 BX	5	HOME	40mm Steel Body, Die cast cover with Boron Shackle - Boxed	44	27	7	18	19	Special	KB P4	BOX	1
VULCAN P4 50 KA	6	HOME	50mm KA Diecast Body Padlock with Boron Shackle	55	33	9.5	23.5	22	Special	KB P4	BOX	1
VULCAN P4 45 KA	5	HOME	45mm KA Diecast Body Padlock with Boron Shackle	48	28	8	19	20.5	Special	KB P4	BOX	1

Closed Shackle



VULCAN P4 45CS



VULCAN P4 50CS

VULCAN P4 50CS BX	7	HOME	50mm Steel Body, Die cast cover with Boron Shackle - Boxed	55	33	9.5	19	16	Special	KB P4	BOX	1
VULCAN P4 45CS	6	HOME	45mm Steel Body, Die cast cover with Boron Shackle	48	28	8	15.2	14	5012245035599	KB P4	PLATFORM	6
VULCAN P4 45CS KA	6	HOME	45mm KA Steel Body, Die cast cover with Boron Shackle	48	28	8	15.2	14	Special	KB P4	BOX	1

Long Shackle



VULCAN P4 40/2.5

VULCAN P4 40/2.5	5	HOME	40mm Steel Body, Die cast cover with Boron Shackle	44	27	7	63	19	5012245035605	KB P4	PLATFORM	6
-------------------------	---	------	--	----	----	---	----	----	---------------	-------	----------	---

CP Range - Combination



A heavy-duty range of recodable combination padlocks

Unique in design, our combination locks are manufactured to the highest standards for quality and performance. Easy to use, they are fully recodable and a number of locks can be coded alike so that one code opens several locks. Many of our locks are patented and have individual design features to improve performance and security.

CP Range - Features

Hardened steel shackle
(Rustproof versions
stainless steel shackles)

Double locking

CP40 and CP50 - 4 Wheels
10,000 combinations

CP60 - 5 Wheels 100,000
combinations

Fully recodable

Die cast alloy
body

Push button opening

New patented design



NEW CP 50/4
100mm shackle clearance



new

100mm



CP Range - Combination

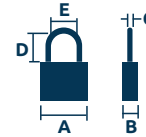

CP Range Padlocks



CP60 - 60mm

Code	Security Rating	@	Description	Dimensions mm					Barcode	Number of Combinations	Pack Type	Min Qty
				A	B	C	D	E				
CP60	6	HOME	60mm Combi Padlock - 5 wheel	60	33	10	34	28	5012245025736	100,000	PLATFORM	3
CP60 BX	6	HOME	60mm Combi Padlock - 5 wheel - Boxed	60	33	10	34	28	Special	100,000	BOX	3
CP60/2.5	6	HOME	CP60 with a 63mm vertical shackle clearance	60	33	10	63	28	5012245025743	100,000	PLATFORM	3
CP60CS	7	HOME	CP60 with closed shackle	60	33	10	29	22	5012245025750	100,000	PLATFORM	3



CP50 - 50mm

CP50	5	HOME	50mm Combi Padlock - 4 wheel	50	26	8	26	22.6	5012245021783	10,000	PLATFORM	6
CP50 BX	5	HOME	50mm Combi Padlock - 4 wheel - Boxed	50	26	8	26	22.6	Special	10,000	BOX	1
CP50/1.5	5	HOME	CP50 with a 38mm vertical shackle clearance	50	26	8	38.1	22.6	5012245021806	10,000	PLATFORM	6
CP50/1.5 BX	5	HOME	CP50 with a 38mm vertical shackle clearance - Boxed	50	26	8	38.1	22.6	Special	10,000	BOX	1
CP50/2.5	5	HOME	CP50 with a 63mm vertical shackle clearance	50	26	8	63.5	22.6	5012245021813	10,000	PLATFORM	6
CP50/2.5 BX	5	HOME	CP50 with a 63mm vertical shackle clearance - Boxed	50	26	8	63.5	22.6	5012245040265	10,000	PLATFORM	1
CP50/4 new	5	HOME	CP50 with a 100mm vertical shackle clearance	50	26	8	100	22.6	Special	10,000	BOX	1
CP50CS	6	HOME	CP50 with closed shackle	50	26	8	100	16	5012245021790	10,000	PLATFORM	3



new



CP40 - 40mm

CP40	4	HOME	40mm Combi Padlock - 4 wheel	40	22	6	20	17	5012245024609	10,000	PLATFORM	6
CP40 BX	4	HOME	40mm Combi Padlock - 4 wheel - Boxed	40	22	6	20	17	Special	10,000	BOXED	6
CP40/2.5	4	HOME	CP40 with a 63mm vertical shackle clearance	40	22	6	63	17	5012245024616	10,000	PLATFORM	6
CP40/2.5 BX	4	HOME	CP40 with a 63mm vertical shackle clearance - Boxed	40	22	6	63	17	Special	10,000	BOXED	6
CP40CS	4	HOME	CP40 with closed shackle	40	22	6	17	13	5012245024623	10,000	PLATFORM	6



Rustproof



The CP Range is also available with chain attachments

Rustproof versions with stainless steel shackles also available, see page 71

Solid Brass Padlocks Premium Grade

The Lion range offers a superior level of security for indoor and outdoor use and is available keyed alike.

Features

- Hardened steel shackle
- Double locking 30mm and above
- Solid brass lock body
- Pin tumbler lock mechanism

Benefits

- Superior security - excellent economic choice
- For internal and external use

NEW LN4/4
100mm shackle clearance



Hardened
steel shackle

Solid brass
lock body

Pin tumbler
lock mechanism



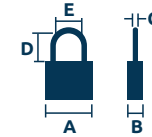

Lion Range - Premium Solid Brass



LN2 LN3 LN4



LN5 LN60



LN4/2.5 LN5/2.5 LN6/4



new

Code	Security Rating	@	Description	Dimensions mm					Barcode	Key Blank	Pack Type	Min Qty
				A	B	C	D	E				
LN2	2	LEISURE	25mm Premium Brass 4 pin	24.5	11.1	4	16.7	13.5	5012245002676	KB LN A SL	PLATFORM	12
LN3	2	LEISURE	30mm Premium Brass 4 pin Double Locking	31.5	13	5.5	19.5	16.5	5012245002683	KB LN A SL	PLATFORM	12
LN4	3	HOME	40mm Premium Brass 5 pin Double Locking	39.5	14	6	21.1	22.5	5012245002690	KBP5	PLATFORM	6
LN5	4	HOME	50mm Premium Brass 5 pin Double Locking	51	15.5	8.8	30	28	5012245002713	KBP5	PLATFORM	6
LN60	5	HOME	60mm Premium Brass 5 pin Double Locking	60	18.6	9.5	35.5	33.5	5012245003376	KBP5	PLATFORM	6
LN4/2.5	3	HOME	2.5" L/S 40mm Premium Brass 5 pin Double Locking	39.5	14	6	64	22.5	5012245002706	KBP5	PLATFORM	6
LN4/4 new	3	HOME	4" L/S 40mm Premium Brass 5 pin Double Locking	39.5	14	6	100	22.2	5012245039368	KBP5	PLATFORM	6
LN5/2.5	4	HOME	2.5" L/S 50mm Premium Brass 5 pin Double Locking	51	15.5	8.8	65	28	5012245006032	KBP5	PLATFORM	6
LN4T	3	HOME	40mm Twinpack KA (2 x LN4 KA on one card)	39.5	14	6	21.1	22.5	5012245003314	KBP5	PLATFORM	6
LN5T	4	HOME	50mm Twinpack KA (2 x LN5 KA on one card)	51	15.5	8.8	30	28	5012245009781	KBP5	PLATFORM	6
LN2 KA1	2	LEISURE	KA 25mm Premium Brass 4 pin Differ No. 2232	24.5	11.1	4	16.7	13.5	Special	KBP5	BOX	12
LN3 KA1	2	LEISURE	KA 30mm Premium Brass 4 pin Double Locking Differ No. 32342	31.5	13	5.5	19.5	16.5	Special	KBP5	BOX	12
LN3 KA2	2	LEISURE	KA 30mm Premium Brass 4 pin Double Locking Differ No. 43223	31.5	13	5.5	19.5	16.5	Special	KBP5	BOX	6
LN4 KA1	3	HOME	KA 40mm Premium Brass 4 pin Double Locking Differ No. 23423	39.5	14	6	21.1	22.5	Special	KBP5	BOX	6
LN4 KA2	3	HOME	KA 40mm Premium Brass 4 pin Double Locking Differ No. 24342	39.5	14	6	21.1	22.5	Special	KBP5	BOX	6
LN4 KA3	3	HOME	KA 40mm Premium Brass 4 pin Double Locking Differ No. 31422	39.5	14	6	21.1	22.5	Special	KBP5	BOX	6
LN5 KA1	4	HOME	KA 50mm Premium Brass 4 pin Double Locking Differ No. 24342	51	15.5	8.8	30	28	Special	KBP5	BOX	6
LN5 KA2	4	HOME	KA 50mm Premium Brass 4 pin Double Locking Differ No. 35524	51	15.5	8.8	30	28	Special	KBP5	BOX	6
LN5 KA3	4	HOME	KA 50mm Premium Brass 4 pin Double Locking Differ No. 31422	51	15.5	8.8	30	28	Special	KBP5	BOX	6
LN60 KA1	5	HOME	KA 60mm Premium Brass 4 pin Double Locking Differ No. 24342	60	18.6	9.5	35.5	33.5	Special	KBP5	BOX	6
LN60 KA2	5	HOME	KA 60mm Premium Brass 4 pin Double Locking Differ No. 31422	60	18.6	9.5	35.5	33.5	Special	KBP5	BOX	6
LN4/2.5 KA1	3	HOME	KA 2.5" L/S 40mm Premium Brass 5 pin Double Locking Differ No. 24342	39.5	14	6	64	22.5	Special	KBP5	BOX	6
LN4/4/KA1 new	6	HOME	KA 4" L/S 40mm Premium Brass 5 pin Double Locking Differ No. 24342	39.5	14	6	100	22.5	Special	KBP5	BOX	6
LN5/2.5 KA1	4	HOME	KA 2.5" L/S 50mm Premium Brass 5 pin Double Locking Differ No. 24342	51	15.5	8.8	65	28	Special	KBP5	BOX	6
LN5/2.5 KA2	4	HOME	KA 2.5" L/S 50mm Premium Brass 5 pin Double Locking Differ No. 35524	51	15.5	8.8	65	28	Special	KBP5	BOX	6

SPECIAL PRODUCTS SERVICE

Sub Assembled Premium Brass Lion Range

The problem

With the huge number of brass padlocks available on the Market – on a limited number of keyed alike systems – creates a real risk of a customers key opening a padlock of another customer nearby.

The potential liability problem resulting from this situation is a real concern to suppliers of these padlocks.

The solution

SQUIRE solves this problem with the new Sub Assembled Lion range. Bespoke key system created and made in our factory means, you can forget concerns of possible key duplication by virtue of the large numbers of key options available.

SQUIRE can build 'In-House', Keyed Alike (KA) suites with up to 1,500 guaranteed differs.

Features

- 1500 guaranteed key differs.
- Padlocks can be made to existing keys.
- Key identification marking.
- All sizes of padlocks can be keyed alike to each other.



Sub Assembled Keyed Alike Brass Padlocks

Sizes available

Hardened steel shackle

LN4 - 40mm
LN4/2.5 - 40mm long shackle
LN5 - 50mm
LN60 - 60mm

Stainless steel shackle

LN4S - 40mm
LN4S/2.5 - 40mm long shackle
LN5S - 50mm



Rustproof
versions available



Marine
versions available

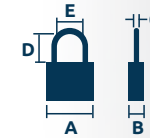

Keyed Alike Brass Padlocks

Code	Security Rating	@	Description	Dimensions mm					Barcode	Key Blank	Pack Type	Min Qty
				A	B	C	D	E				
LN4/KA	3	HOME	40mm Premium Brass 5 pin Double Locking	39.5	14	6	21.1	22.5	Special	KBP5	BOX	1
LN4/2.5/KA	3	HOME	40mm Premium Brass 5 pin Double Locking with 2.5 inch shackle	39.5	14	6	63	22.5	Special	KBP5	BOX	1
LN5/KA	4	HOME	50mm Premium Brass 5 pin Double Locking	51	15.5	8.8	30	28	Special	KBP5	BOX	1
LN60/KA	5	HOME	60mm Premium Brass 5 pin Double Locking	60	18.6	9.5	35.5	33.5	Special	KBP5	BOX	1
LN4S/KA	3	MARINE	40mm Premium Brass 5 pin Double Locking with stainless steel shackle	39.5	14	6.5	22	22.5	Special	KB LN C SL	BOX	1
LN4S/2.5/KA	3	MARINE	40mm Premium Brass 5 pin Double Locking with 2.5 inch stainless steel shackle	39.5	14	6.5	63	22.5	Special	KB LN C SL	BOX	1
LN5S/KA	4	MARINE	50mm Premium Brass 5 pin Double Locking with stainless steel shackle	51	15.5	8.8	30	28	Special	KB LN A SL	BOX	1

Guaranteed Keyed to Differ Brass Padlocks

This 'In-House' facility also enables the ability to build Keyed to Differ (KD) suites of padlocks, that are guaranteed non-interpassing

LN4/KD/SP	3	HOME	40mm Premium Brass 5 pin Double Locking	39.5	14	6	21.1	22.5	Special	KBP5	BOX	1
LN4/2.5/KD/SP	3	HOME	40mm Premium Brass 5 pin Double Locking with 2.5 inch shackle	39.5	14	6	63	22.5	Special	KBP5	BOX	1
LN5/KD/SP	4	HOME	50mm Premium Brass 5 pin Double Locking	51	15.5	8.8	30	28	Special	KBP5	BOX	1
LN60/KD/SP	5	HOME	60mm Premium Brass 5 pin Double Locking	60	18.6	9.5	35.5	33.5	Special	KBP5	BOX	1
LN4S/KD/SP	3	MARINE	40mm Premium Brass 5 pin Double Locking with stainless steel shackle	39.5	14	6.5	22	22.5	Special	KB LN C SL	BOX	1
LN4S/2.5/KD/SP	3	MARINE	40mm Premium Brass 5 pin Double Locking with 2.5 inch stainless steel shackle	39.5	14	6.5	63	22.5	Special	KB LN C SL	BOX	1
LN5S/KD/SP	4	MARINE	50mm Premium Brass 5 pin Double Locking with stainless steel shackle	51	15.5	8.8	30	28	Special	KB LN A SL	BOX	1

The keys and locks can also be marked with a code, company logo, branding, etc on our laser etching machine at an additional cost, price on application.



Harsh Environment Padlocks

Highly weather resistant padlocks **NEW** suitable for the harshest of environments

Squire have updated their All Terrain padlocks to a new design. These highly weather resistant rustproof padlocks are manufactured to the highest standards for quality performance even under the harshest environmental conditions.

ATL Range - Features

Stainless steel shackles, 6mm on the ATL42S and 8mm on the ATL52S

Solid brass lock body, two body widths available, 44mm and 58mm

All weather, protective body and key hole cover for extra resistance to the environment

Pin tumbler cylinder



Rustproof



Stainless steel shackle



240 YEARS
OF LOCKMAKING EXCELLENCE

Harsh Environment Padlocks

new



All terrain padlocks

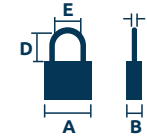

Code	Security Rating	@	Description	Dimensions mm					Barcode	Key Blank	Pack Type	Min Qty
				A	B	C	D	E				
ATL42S	3	HOME	All Terrain 40mm Brass Padlock Stainless Shackle in a protective sleeve	44	20	6	20	22	5012245037883	KBP5	PLATFORM	6
ATL52S	4	HOME	All Terrain 50mm Brass Padlock Stainless Shackle n a protective sleeve	58	25	8.8	29	28	5012245037920	KBP5	PLATFORM	6
ATL42SKA1	3	HOME	All Terrain 40mm KA Brass Padlock Stainless Shackle Key Differ No. 24342	44	20	6	20	22	5012245037890	KBP5	BOX	1
ATL52SKA1	4	HOME	All Terrain 50mm KA Brass Padlock Stainless Shackle Key Differ No. 24342	58	25	8.8	29	28	5012245037937	KBP5	BOX	1

Old English



Code	Security Rating	@	Description	Dimensions mm					Barcode	Key Blank	Pack Type	Min Qty
				A	B	C	D	E				
220	2	HOME	Small Old English Galvanised Steel 4 Lever	38	14.5	7	11	12	5012245000221	KB 220	PLATFORM	6
440	3	HOME	Medium Old English Galvanised Steel 4 Lever	51	16.5	8	18	18	5012245000269	KB 440	PLATFORM	6
660	3	HOME	Large Old English Galvanised Steel 4 Lever	64	19.7	10	21	21	5012245000290	KB 660	PLATFORM	6
220KA	2	HOME	KA Small Old English Galvanised Steel 4 Lever	38	14.5	7	11	12	Special	KB 220	BOX	1
440KA	3	HOME	KA Medium Old English Galvanised Steel 4 Lever	51	16.5	8	18	18	Special	KB 440	BOX	1
660KA	3	HOME	KA Large Old English Galvanised Steel 4 Lever	64	19.7	10	21	21	Special	KB 660	BOX	1

Old English - Marine Grade



555

555	3	MARINE	Medium Old English Stainless Steel 4 Lever	51	16.5	8	18	18	501224539894	KB 440	PLATFORM	6
555KA	3	MARINE	Medium Old English Stainless Steel 4 Lever Keyed Alike	51	16.5	8	18	18	Special	KB 440	BOX	1



39 Range



37 Range



35 Range

Stronglock™ Range

Steel Pin Tumbler

- Hardened steel shackle
- Double deadlocking, ball locking, spring locking
- Covered steel padlock body with anti-corrosion finish gives corrosion resistance
- 4 Pin tumbler lock mechanism gives over 1,000 key differs
- Medium duty security
- Available masterkeyed and keyed alike

Hardened steel shackle

Double deadlocking, ball locking, spring locking

Covered laminated steel padlock body with anti-corrosion finish

4 Pin tumbler lock mechanism gives over 1,000 key differs

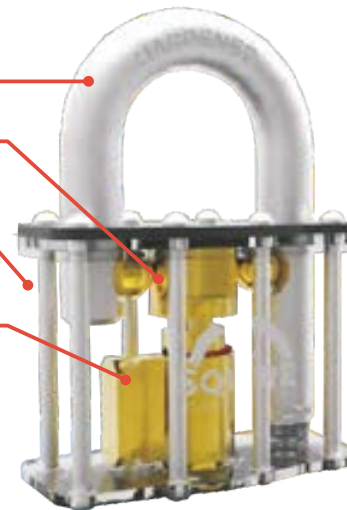

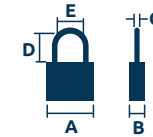

Stronglock™ Pin Tumbler



Code	Security Rating	@	Description	Dimensions mm					Barcode	Key Blank	Pack Type	Min Qty	MK
				A	B	C	D	E					
35	4	HOME	40mm Laminated Double Locking Padlock 4 pin	44	23	7	17	16	5012245000795	KB P4	PLATFORM	6	■
35 BX	4	HOME	40mm Laminated Double Locking Padlock 4 pin - Boxed	44	23	7	17	16	Special	KB P4	BOX	1	■
37	4	HOME	45mm Laminated Double Locking Padlock 4 pin	49	24	8	20	20	5012245000856	KB P4	PLATFORM	6	■
39	5	HOME	50mm Laminated Double Locking Padlock 4 pin	54	29	9	24	24	5012245000917	KB P4	PLATFORM	6	■
39 BX	5	HOME	50mm Laminated Double Locking Padlock 4 pin - boxed	54	29	9	24	24	Special	KB P4	BOX	1	■
35KA	4	HOME	40mm KA Laminated Double Locking Padlock 4 pin	44	23	7	17	16	Special	KB P4	BOX	1	■
37KA	4	HOME	45mm KA Laminated Double Locking Padlock 4 pin	49	24	8	20	20	Special	KB P4	BOX	1	■
39KA	5	HOME	50mm KA Laminated Double Locking Padlock 4 pin	54	29	9	24	24	Special	KB P4	BOX	1	■
37CS	5	HOME	45mm Closed Shackle Laminated Double Locking Padlock 4 pin	49	24	8	13	20	5012245003680	KB P4	PLATFORM	1	■
39CS	6	HOME	50mm Closed Shackle Laminated Double Locking Padlock 4 pin	54	29	9	19	16	5012245003697	KB P4	PLATFORM	3	■
37CSKA	5	HOME	45mm KA Closed Shackle Laminated Double Locking Padlock 4 pin	49	24	8	13	20	Special	KB P4	PLATFORM	1	■
39CSKA	6	HOME	50mm KA Closed Shackle Laminated Double Locking Padlock 4 pin	54	29	9	19	16	Special	KB P4	BOX	1	■
35/1.5	4	HOME	40mm 1.5" Long Shackle Laminated Double Locking Padlock 4 pin	44	23	7	39	16	5012245000825	KB P4	BOX	6	■
35/2.5	4	HOME	40mm 2.5" Long Shackle Laminated Double Locking Padlock 4 pin	44	23	7	64.8	16	5012245000832	KB P4	PLATFORM	6	■
37/2.5	4	HOME	45mm 2.5" Long Shackle Laminated Double Locking Padlock 4 pin	49	24	8	64.4	20	5012245000887	KB P4	BOX	6	■
39/1.5	5	HOME	50mm 1.5" Long Shackle Laminated Double Locking Padlock 4 pin	54	29	9	39	24	5012245000931	KB P4	BOX	6	■
39/2.5	5	HOME	50mm 2.5" Long Shackle Laminated Double Locking Padlock 4 pin	54	29	9	64.5	24	5012245000948	KB P4	PLATFORM	6	■
35/1.5KA	4	HOME	40mm KA 1.5" Long Shackle Laminated Double Locking Padlock 4 pin	44	23	7	39	16	Special	KB P4	BOX	1	■
35/2.5KA	4	HOME	40mm KA 2.5" Long Shackle Laminated Double Locking Padlock 4 pin	44	23	7	64.8	16	Special	KB P4	BOX	1	■
37/2.5KA	4	HOME	45mm KA 2.5" Long Shackle Laminated Double Locking Padlock 4 pin	49	24	8	64.4	20	Special	KB P4	BOX	1	■
39/1.5KA	5	HOME	50mm KA 1.5" Long Shackle Laminated Double Locking Padlock 4 pin	54	29	9	39	24	Special	KB P4	BOX	1	■
39/2.5KA	5	HOME	50mm KA 2.5" Long Shackle Laminated Double Locking Padlock 4 pin	54	29	9	64.5	24	Special	KB P4	BOX	1	■
35T	4	HOME	Twin pack Keyed Alike (2 x 35KA on one card)	44	23	7	17	16	5012245000818	KB P4	PLATFORM	6	■
35CLR	4	HOME	Assorted Colours 40mm Laminated Double Locking Padlock 4 pin	44	23	7	17	16	Special	KB P4	BOX	1	■
35CLRKA	4	HOME	KA Assorted Colours 40mm Laminated Double Locking Padlock 4 pin	44	23	7	17	16	Special	KB P4	BOX	1	■
35C	4	HOME	No 35 padlock with 305mm chain attached	44	23	7	17	16	5012245000849	KB P4	BOX	1	■
37C	4	HOME	No 37 padlock with 305mm chain attached	49	24	8	20	20	5012245000900	KB P4	BOX	1	■
39C	5	HOME	No 39 padlock with 305mm chain attached	54	29	9	24	24	5012245000962	KB P4	BOX	1	■
35CKA	4	HOME	KA No. 35 padlock with 305mm chain attached	44	23	7	17	16	Special	KB P4	BOX	1	■
37CKA	4	HOME	KA No. 37 padlock with 305mm chain attached	49	24	8	20	20	Special	KB P4	BOX	1	■
39CKA	5	HOME	KA No. 39 padlock with 305mm chain attached	54	29	9	24	24	Special	KB P4	BOX	1	■

MK Denotes Master Keyed, prices upon application

Stronglock™ Keyed Alike KIT



Laminated Padlocks - P4 Keyed Alike KIT

Create keyed alike suites quickly and easily, eliminating many of the problems associated with pinning padlocks



Laminated Padlocks - P4 Keyed Alike KIT

- The padlock comes with the cylinder in place enabling you to pin through the pinning hole in the side of the padlock
- No problems inserting the cylinders, no need to worry about misaligned and badly fitting cylinders
- Inserting the pins is easy, using the pin loader tool to help guide you insert pins, drivers and springs
- Quick and easy to use
- No need to involve the lock manufacturer - do the job in-house to your customers timescale
- Makes providing keyed alike systems quick, easy and profitable for the locksmith

For full break down of P4 Keyed Alike KIT components see overleaf

100 pins x 5 types, 400 x pin drivers, 400 x springs, Key reader, Pin loader tool, Loading punch tool. Comes in attractive tidy box



P4 Keyed Alike KIT

Code	Security Rating	@	Description	Barcode	Key Blank	Pack Type	Min Qty
LAM/P4/PINKIT	N/A	HOME	Kit for P4 Laminated pinnable padlocks - Supplied in Luxury Plastic Case	n/a	KB P4	BOX	1

Laminated Padlocks - P4 Keyed Alike KIT - Components

Code	Description	Barcode	Key Blank	Pack Type
LAM/P4/COREPIN/0	P4 Std Differ Pin 0 (BAG 100)	Special	n/a	BAG
LAM/P4/COREPIN/1	P4 Std Differ Pin 1 (BAG 100)	Special	n/a	BAG
LAM/P4/COREPIN/2	P4 Std Differ Pin 2 (BAG 100)	Special	n/a	BAG
LAM/P4/COREPIN/3	P4 Std Differ Pin 3 (BAG 100)	Special	n/a	BAG
LAM/P4/COREPIN/4	P4 Std Differ Pin 4 (BAG 100)	Special	n/a	BAG
LAM/P4/COREPIN/5	P4 Std Differ Pin 5 (BAG 100)	Special	n/a	BAG
LAM/P4/TOPPIN/1	P4 Driver Top Pin 1 (BAG 100)	Special	n/a	BAG
LAM/P4/BODY SPRING	P4 Body Spring (BAG 100)	Special	n/a	BAG
LAM/P4/BL	P4 Key Blank	Special	KB P4	BAG
LAM/P4/JIG/UNIV	P4 Jig for No.35/37/39 Assembly	Special	n/a	BAG
LAM/P4/LOADING/PUNCH	P4 Punch to assist Pin Assembly	Special	n/a	BAG
LAM/P4/KEYREADER	P4 Key Reader	Special	n/a	BAG
LAM/P4/CAPBLOCK	P4 Cap Stopper Block	Special	n/a	BAG
LAM/P4/DEPTH/SET	P4 Set of 6 Depth Keys	Special	n/a	BAG
LAM/P4/35/KIT	35 Body c/w Blk Sleeve & 2 Key BL	Special	KB P4	BAG
LAM/P4/35/1.5/KIT	35/1.5 Body c/w Blk Sleeve & 2 Key BL	Special	KB P4	BAG
LAM/P4/35/2.5/KIT	35/2.5 Body c/w Blk Sleeve & 2 Key BL	Special	KB P4	BAG
LAM/P4/37/KIT	37 Body c/w Blk Sleeve & 2 Key BL	Special	KB P4	BAG
LAM/P4/37/2.5/KIT	37/2.5 Body c/w Blk Sleeve & 2 Key BL	Special	KB P4	BAG
LAM/P4/39/KIT	39 Body c/w Blk Sleeve & 2 Key BL	Special	KB P4	BAG
LAM/P4/39/1.5/KIT	39/1.5 Body c/w Blk Sleeve & 2 Key BL	Special	KB P4	BAG
LAM/P4/39/2.5/KIT	39/2.5 Body c/w Blk Sleeve & 2 Key BL	Special	KB P4	BAG
LAM/P4/35/CLR/SLEEVE	Coloured Sleeve for No.35 Padlock	Special	n/a	BAG
LAM/P4/37/CLR/SLEEVE	Coloured Sleeve for No.37 Padlock	Special	n/a	BAG
LAM/P4/39/CLR/SLEEVE	Coloured Sleeve for No.39 Padlock	Special	n/a	BAG
LAM/P4/35/BLK/SLEEVE	Black Sleeve for No.35 Padlock	Special	n/a	BAG
LAM/P4/37/BLK/SLEEVE	Black Sleeve for No.37 Padlock	Special	n/a	BAG
LAM/P4/39/BLK/SLEEVE	Black Sleeve for No.39 Padlock	Special	n/a	BAG



Keybolt™ Weatherproof Locking Bolt



- Steel lock body and bolt encased in a weatherproof cover
- Steel components
- 4 Lever lock mechanism
- Lever lock mechanism gives excellent reliability outdoors
- Can be used in or outdoors



All weather



Uses: Sheds, gates, cupboards, storage areas, cabinets, lockers, small vans, internal and external doors.

Keybolt™ - Weatherproof Locking Bolt



KEYBOLT

Code	Security Rating	@	Description	Dimensions mm			Barcode	Key Blank	Pack Type	Min Qty
				A	B	C				
KEYBOLT	4	HOME	Weatherproof locking bolt - key operated	113	68	30	5012245031027	KB 220	PLATFORM	6
KEYBOLT BX	4	HOME	Weatherproof locking bolt - BOXED	113	68	30	5012245031027	KB 220	BOX	6

Integrated Locking Hasp



INTEGRATED

Code	Security Rating	@	Description	Dimensions mm			Barcode	Key Blank	Pack Type	Min Qty
				A	B	C				
LH1	4	HOME	Locking Hasp & staple	152	44	23	5012245007794	KB LH1	PLATFORM	6

Hasp and Staples



No.6H

Code	Security Rating	@	Description	Dimensions mm				Barcode	Pack Type	Min Qty
				A	B	C	Staple Clearance			
NO.6H	6	HOME	Hardened Steel hasp	152	44	23	12.5	5012245000511	PLATFORM	6
DHH1	5	HOME	Double hinge hasp & staple	200	45.8	32	12.7	5012245004458	HANGING BOX	6



DHH1



Combi-Bolt™

Unique recodable locking bolt

- Die cast lock body
- Steel bolt
- Recodable CombiBolt 3 - 3 wheels for 1,000 combinations
- Recodable CombiBolt 4 - 4 wheels for 10,000 combinations
- Recodable CombiBolt 5 - 5 wheels for 100,000 combinations
- No Keys to Lose
- One handed operation
- Security screws included in pack
- High pick resistance
- Patented
- Replaces a padlock and hasp & staple

Uses

Sheds, cupboards, storage areas, cabinets, lockers



Can be
coded alike



No keys
to lose



Rustproof



All
Weather



Combi-Bolt 5™



Combi-Bolt 4™



Combi-Bolt 3™



Combi-Bolt 3™



Code	Security Rating	@	Description	Dimensions mm			Barcode	Number of Combinations	Pack Type	Min Qty
				A	B	C				
COMBI3	3	HOME	92mm Combination Bolt blue die cast recodable	92	35	33	5012245031034	1,000	PLATFORM	4
COMBI3BX	3	HOME	92mm Combination Bolt blue die cast recodable - Boxed	92	35	33	Special	1,000	BOX	4
COMBI3 CH	3	HOME	92mm Chrome finish Combination Bolt recodable	92	35	33	5012245031041	1,000	PLATFORM	4

Combi-Bolt 4™



Code	Security Rating	@	Description	Dimensions mm			Barcode	Number of Combinations	Pack Type	Min Qty
				A	B	C				
COMBI4	4	HOME	120mm Combination Bolt blue die cast recodable	120	50	40	5012245009002	10,000	PLATFORM	4
COMBI4BX	4	HOME	120mm Combination Bolt blue die cast recodable - Boxed	120	50	40	Special	10,000	BOX	4
COMBI4 CH	4	HOME	120mm Chrome finish Combination Bolt recodable	120	50	40	5012245020182	10,000	PLATFORM	4

Combi-Bolt 5™



Code	Security Rating	@	Description	Dimensions mm			Barcode	Number of Combinations	Pack Type	Min Qty
				A	B	C				
COMBI5	5	WORK	150mm Combination Bolt blue die cast recodable	150	60	40	5012245035551	100,000	PLATFORM	2
COMBI5BX	5	WORK	150mm Combination Bolt blue die cast recodable - Boxed	150	60	40	Special	100,000	BOX	2

LEISURE

@Leisure is for when you're out and about. Marine grade locks for boats and harsh weather conditions. The range also includes luggage and travel locks for when you're flying abroad, or for your trailer or caravan.

New leisure products 2023

This year sees the introduction of the new CP All Terrain range of padlocks. An extremely durable, rustproof, weather protected range based upon Squire's extremely popular and well established CP Range. These locks have been salt spray tested for 312 hours. See page 66

Also, see Squire's new LEISURE - MARINE GRADE range. This category of locks is an extension of the regular LEISURE range having features that enhance performance in wet conditions. The padlocks in this range incorporate stainless steel shackles and many have been salt spray tested. See page 69.



CP All Terrain



Lion Range



CP Range



All Terrain

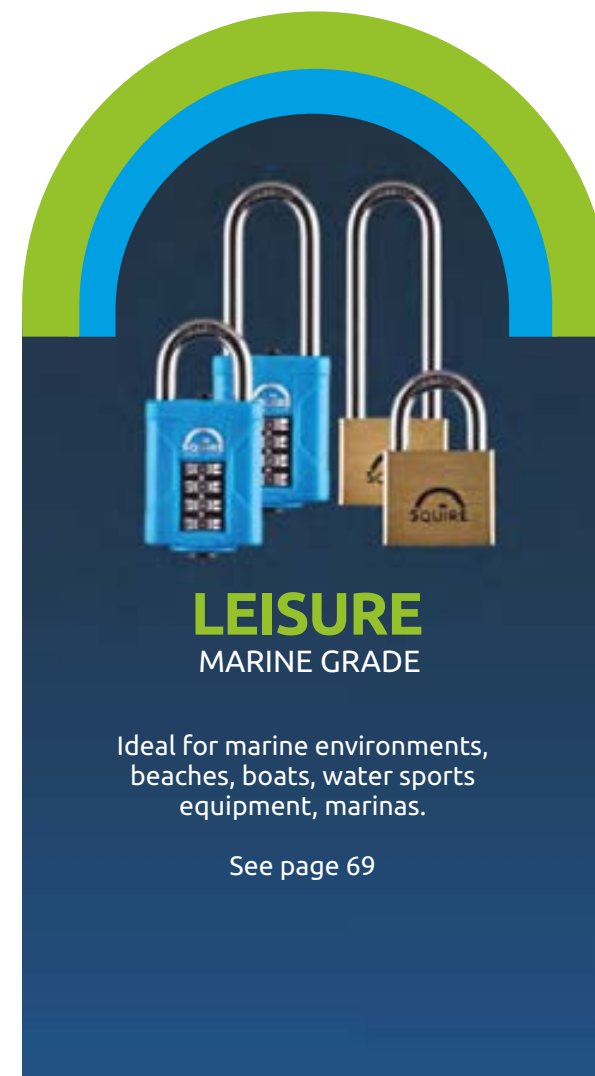

LEISURE

MARINE GRADE

Ideal for marine environments,
beaches, boats, water sports
equipment, marinas.

See page 69

Product usage

- Out and about
- Recreational gear
- Suitcase
- Caravan / camping
- BBQ
- Sport locker
- Marine

Why choose LEISURE

- Tough rustproof and weather-proof
- Guaranteed 10 years
- Mostly combi
- Salt spray tested

Security rating

Basic 1-4

Squire LEISURE brands

- CP Combination CP30
- CP All Terrain
- **Lion**
- Luggage and travel locks
- Lock and chain sets
- Cables

Security rating

Basic 1-4

All Terrain combination locks - **NEW** ideal for the harshest environments

The new CP All Terrain locks combine all of the features of Squire's highly popular CP combination range with added weather protection features. Seriously tough locks, built to withstand the harshest of weather conditions and challenging environments. Tested to 312 hours Salt Spray. Available in standard dark blue, high visibility orange and RUSTPROOF light blue versions. Standard and long shackle variants available.

Features

- Unique angled shackle, available with hardened steel shackle with black anti-corrosion finish or in stainless steel design for guaranteed rust-proof protection
- Robust TPE easy grip body cover
- 50mm die cast lock body
- Special weather protective wheel cover
- Push button opening. Angled button on the bottom of the padlock to provide easier opening of lock
- 4 Wheels - 10,000 possible combinations. Fully recodable



Passed 312 hour
salt spray test



All Weather



All Terrain



CP All Terrain Range - Combination

CP All Terrain standard

new



Black and dark blue versions. Available with standard shackle and 2.5 inch shackle versions.

CP All Terrain orange

new



Ideal for high visibility applications and as a visible deterrent.

CP All Terrain stainless shackles
Rustproof

new



Rustproof versions with stainless steel shackles. Ideal for marine applications.

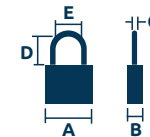

CP50 All Terrain Open Shackle

Code	Security Rating	@	Description	Dimensions mm					Barcode	Number of Combinations	Pack Type	Min Qty
				A	B	C	D	E				
CP50/ATL BX	5	LEISURE	50mm Combination Padlock - 4 Wheel - Protective Cover	50	36	8	23	22	5012245039016	10,000	BOX	6
CP50/ATL/2.5 BX	5	LEISURE	50mm 2.5" Shackle Combination Padlock - 4 Wheel - Protective Cover	50	36	8	63	22	5012245039030	10,000	BOX	6
CP50/ATLO BX	5	LEISURE	50mm Combination Padlock - 4 Wheel - Protective Cover - Orange	50	36	8	23	22	5012245039009	10,000	BOX	6
CP50/ATLO/2.5 BX	5	LEISURE	50mm 2.5" Shackle Combination Padlock - 4 Wheel - Protective Cover - Orange	50	36	8	63	22	5012245039023	10,000	BOX	6
CP50/ATLS BX	4	LEISURE	50mm Combination Padlock - 4 Wheel - Protective Cover with stainless steel shackle	50	36	8	23	22	5012245039047	10,000	BOX	6
CP50/ATLS/2.5 BX	4	LEISURE	50mm 2.5" Shackle Combination Padlock - 4 Wheel - Protective Cover with stainless steel shackle	50	36	8	63	22	5012245039054	10,000	BOX	6

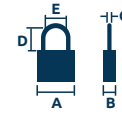

Lion Range

Code	Security Rating	@	Description	Dimensions mm					Barcode	Key Blank or No of combinations	Pack Type	Min Qty
				A	B	C	D	E				
LN2	2	LEISURE	25mm Premium Brass 4 pin	24.5	11.1	4	16.7	13.5	5012245002676	KB LN A SL	PLATFORM	12
LN3	2	LEISURE	30mm Premium Brass 4 pin Double Locking	31.5	13	5.5	19.5	16.5	5012245002683	KB LN C SL	PLATFORM	12
LN2KA	2	LEISURE	KA 25mm Premium Brass 4 pin	24.5	11.1	4	16.7	13.5	Special	KB LN A SL	BOX	12
LN3KA	2	LEISURE	KA 30mm Premium Brass 4 pin Double Locking	31.5	13	5.5	19.5	16.5	Special	KB LN C SL	BOX	12



All terrain padlocks

Code	Security Rating	@	Description	A	B	C	D	E	Barcode	Key Blank or No of combinations	Pack Type	Min Qty
ATL42S	3	HOME	All Terrain 40mm Brass Padlock Stainless Shackle	44	20	6	20	22	5012245037883	KB LN C SL	PLATFORM	6
ATL52S	4	HOME	All Terrain 50mm Brass Padlock Stainless Shackle	58	25	8.8	29	28	5012245037920	KB LN C SL	PLATFORM	6
ATL42SKA1	3	HOME	All Terrain 40mm KA Brass Padlock Stainless Shackle Key Differ No. 24342	44	20	6	20	22	5012245037890	KB LN C SL	BOX	1
ATL52SKA1	4	HOME	All Terrain 50mm KA Brass Padlock Stainless Shackle Key Differ No. 24342	58	25	8.8	29	28	5012245037937	KB LN C SL	BOX	1

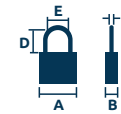

Lock and Chain Sets

Code	SECURITY RATING	@	Description	Link Diameter	Chain Length	Dimensions mm					Barcode	Key Blank or No of combinations	Pack Type	Min Qty
						A	B	C	D	E				
3936	5	LEISURE	39 lock with hardened square link chain (X3)	8	915	51	29	9	24	24	5012245003642	KB 02	BOX	6
3536	6	LEISURE	35 lock with hardened steel chain	5	900	38	23	7	17	16	5012245001587	KB 02	BOX	6
CP50/36	7	LEISURE	CP50 Combi with hardened square link chain (X3)	8	915	50	26	8	26	22.6	5012245027945	10000	BOX	6

3936 and 3536 Can be supplied master keyed upon request

MARINE GRADE LEISURE

- A range designed specifically for marine environments
- Stainless steel shackles - rustproof, excellent performance in harsh weather conditions
- Four ranges of lock, CP combination and Lion premium brass
- All locks come with Squires 10 year guarantee as standard



Old English 555 The **Ultimate** Marine Padlock Withstands total submersion under water

Squire's NEW Old English 555 padlock takes anti-corrosion, waterproof performance to the highest level. The iconic Squire Old English padlocks were first introduced in 1954 and have long been used in underwater situations. Nearly 70 years later, Squire is proud to launch Old English 555, the first Old English padlock with stainless steel shackle and body.

Central to this lock's incredible performance in wet conditions is its four-lever lock mechanism made from brass with electrophoretic nickel coating. These locks have been salt spray tested to 480 hours and meet the highest European corrosion resistance standard (EN 1670 - Grade 5).

Ideal for marine environments, boats, jet skis, beach huts, fishing equipment, marinas, harbour and beach locations.



Passed 480 hour
salt spray test



Rustproof



Marine



NEW



Old English - Marine Grade

Code	Security Rating	@	Description	Dimensions mm					Barcode	Key Blank	Pack Type	Min Qty
				A	B	C	D	E				
555	3	MARINE	Medium Old English Stainless Steel 4 Lever	51	16.5	8	18	18	501224539894	KB 440	PLATFORM	6
555KA	3	MARINE	Medium Old English Stainless Steel 4 Lever Keyed Alike	51	16.5	8	18	18	Special	KB 440	BOX	1

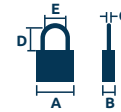

Lion Range - Marine Grade



Code	Security Rating	@	Description	Dimensions mm					Barcode	Key Blank or No of combinations	Pack Type	Min Qty
				A	B	C	D	E				
LN3S	2	MARINE	30mm Premium Brass 4 pin with stainless steel shackle	31.5	13	5.5	19.5	16.5	5012245039344	KB LN A SL	PLATFORM	12
LN4S	3	MARINE	40mm Premium Brass 5 pin with stainless steel shackle	39.5	14	6.5	22	22.5	5012245039313	KB LN C SL	PLATFORM	6
LN5S	4	MARINE	40mm Premium Brass 5 pin with stainless steel shackle	51	15.5	8.8	30	28	5012245039320	KB LN A SL	PLATFORM	6
LN4S/2.5	3	MARINE	40mm Premium Brass 5 pin with 2.5" stainless steel shackle	39.5	14	6.5	63	22.5	5012245039337	KB LN C SL	PLATFORM	6
LN3S/KA1	2	MARINE	KA 30mm Premium Brass 4 pin with stainless steel shackle	31.5	13	5.5	19.5	16.5	5012245039412	KB LN A SL	BOX	1
LN4S/KA1	3	MARINE	KA 40mm Premium Brass 5 pin with stainless steel shackle	39.5	14	6.5	22	22.5	5012245039405	KB LN C SL	BOX	1
LN5S/KA1	4	MARINE	KA 40mm Premium Brass 5 pin with stainless steel shackle	51	15.5	8.8	30	28	5012245039061	KB LN A SL	BOX	1
LN4S/2.5/KA1	3	MARINE	KA 40mm Premium Brass 5 pin with 2.5" stainless steel shackle	39.5	14	6.5	63	22.5	5012245039399	KB LN C SL	BOX	1

CP Range - Marine Grade

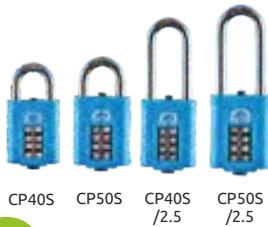

new

Code	Security Rating	@	Description	A	B	C	D	E	Barcode	Key Blank or No of combinations	Pack Type	Min Qty
CP40S	3	MARINE	40mm Rustproof Combi Padlock - 4 wheel - stainless steel shackle	40	22	6	20	17	5012245029642	10,000	PLATFORM	6
CP40S BX	3	MARINE	40mm Rustproof Combi Padlock - 4 wheel - stainless steel shackle - Boxed	40	22	6	20	22.6	Special	10,000	BOX	1
CP50S	4	MARINE	50mm Rustproof Combi Padlock - 4 wheel - stainless steel shackle	50	26	8	26	22.6	5012245029659	10,000	PLATFORM	6
CP50S BX	4	MARINE	50mm Rustproof Combi Padlock - 4 wheel - stainless steel shackle - Boxed	50	26	8	26	22.6	Special	10,000	BOX	1
CP40S/2.5	3	MARINE	40mm Rustproof Combi Padlock - 4 wheel - 2.5" stainless steel shackle	40	22	6	63	22.6	5012245039351	10,000	PLATFORM	6
CP50S/2.5	4	MARINE	50mm Rustproof Combi Padlock - 4 wheel - 2.5" stainless steel shackle	50	26	8	63	22.6	5012245039429	10,000	PLATFORM	6
CP50S/2.5 BX	4	MARINE	50mm Rustproof Combi Padlock - 4 wheel - 2.5" stainless steel shackle	50	26	8	63	22.6	Special	10,000	BOX	1

All terrain padlocks - Marine Grade



new

Code	Security Rating	@	Description	A	B	C	D	E	Barcode	Key Blank or No of combinations	Pack Type	Min Qty
ATL42SM	3	MARINE	All Terrain 40mm Brass Padlock Stainless Shackle	44	20	6	20	22	5012245040036	KB LN C SL	PLATFORM	6
ATL52SM	4	MARINE	All Terrain 50mm Brass Padlock Stainless Shackle	58	25	8.8	29	28	5012245040043	KB LN C SL	PLATFORM	6
ATL42SMKA1	3	MARINE	All Terrain 40mm KA Brass Padlock Stainless Shackle Key Differ No. 24342	44	20	6	20	22	5012245040043	KB LN C SL	BOX	1
ATL52SMKA1	4	MARINE	All Terrain 50mm KA Brass Padlock Stainless Shackle Key Differ No. 24342	58	25	8.8	29	28	5012245040067	KB LN C SL	BOX	1



STH100 Padbar

- High security padbar with hardened hasp and staple
- Hardened special cast material - extremely strong
- Hardened rotating stud for extra resistance to attack
- For use only with the SS100CS padlock. Product meets LPCB SR4 when used together.



STH1 Padbar

- High security padbar with hardened hasp and staple
- Hardened special cast material - extremely strong
- Easy to fit
- Hardened rotating staple for extra resistance to attack



STH3

- Hardened steel construction with anti-corrosion finish
- Hardened steel staple
- Nut and bolt fixing for added security
- Concealed fixings
- Sold Secure security padlocks & fittings SILVER
- Meets new building regulation requirement for out-buildings security



DHH1

- Double hinge flexible hasp and staple
- Steel construction
- Hardened steel staple
- Double hinge - can be used on single and double doors
- Black anti-corrosion finish



No.8

- Hardened steel hasp and staple
- Hardened steel construction with anti-corrosion finish
- Coach bolt fixings for added security
- Concealed fixings
- Can be used on single or double doors



No.6H

- Hardened steel hasp and staple
- Hardened steel construction with anti-corrosion finish
- Coach bolt fixings for added security
- Concealed fixings
- Can be used on single or double doors



STH100



STH1

Stronghold® Security products - CEN Grade



Code	CEN	LPCB	Security Rating	@	Description	Dimensions mm					Barcode	Key Blank	Pack Type	Min Qty
						A	B	C	Staple Clearance	Bolt Dia				
STH100	CEN 6	SR4*	10	WORK	Hardened Stronghold Padbar - CEN 6 for SS100CS only	184	86	32	n/a	18	5012245038828	n/a	BOX	1
STH1			10	WORK	Hardened Stronghold Padbar - CEN 6	184	86	32	16	18	5012245007770	n/a	BOX	1

* LPCB Level 4 only when used in combination with a SS100CS padlock



STH3



No.8



No.6H



DHH1



Hasp and staples



Code	CEN	Security Rating	@	Description	Dimensions mm				Barcode	Pack Type	Min Qty
					A	B	C	Staple Clearance			
STH3	CEN 4	9	WORK	Extra High Security hasp & staple - CEN 4	231	76	52.5	13	5012245038064	PLATFORM	1
NO.8		7	WORK	Hardened steel hasp & staple	216	54.2	38	25	5012245003284	PLATFORM	2
NO.6H		6	HOME	Hardened steel hasp & staple	152	44	23	12.5	5012245000511	PLATFORM	6
DHH1		5	HOME	Double hinge hasp & staple	200	45.8	32	12.7	5012245004458	HANGING BOX	6



LH1



39/NO.6H



39/NO.6H KA

Lock and Hasp Sets



Code	Security Rating	@	Description	Dimensions mm			Padlock Dimensions					Barcode	Key Blank	Pack Type	Min Qty
				A	B	C	A	B	C	D	E				
LH1	4	HOME	Locking Hasp & staple	152	44	23						5012245007794	KB LH1	PLATFORM	6
39/NO.6H	5	HOME	Laminated Padlock 4 pin & hasp set	152	44	23	51	29	9	24	24	5012245009828	KB 02	BOX	1
39/NO.6H KA	5	HOME	KA Laminated Padlock 4 pin & hasp set	152	44	23	51	29	9	24	24	Special	KB 02	BOX	1

The Squire Chains Ranges



Stronghold®
TC22

Diameter - 22mm
Length - 1500mm
Hardened Alloy Steel



Stronghold®
TC19

Diameter - 19mm
Length - 1500mm
Hardened Alloy Steel



Stronghold®
TC16

Diameter - 16mm
Length - 1500mm
Hardened Alloy Steel



Stronghold®
TC14

Diameter - 14mm
Lengths - 915mm, 1200mm
Hardened Alloy Steel



Stronghold®
G Chain

Diameter - 10mm
Lengths - 915mm, 1200mm
1500mm, 2000mm
Hardened Alloy Steel





Stronghold®
J Chain

Diameter - 8mm
Lengths - 915mm, 1200mm
Hardened Alloy Steel



Stronglock®
Y Chain

Diameter - 10mm
Lengths - 900mm, 1200mm, 1800mm
Hardened Steel



Stronglock®
X Chain

Diameter - 8mm
Lengths - 900mm, 1200mm
Hardened Steel

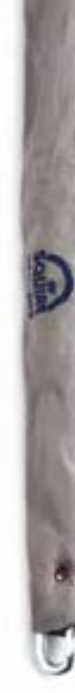

Toughlok™
CP Chain

Diameter - 6.5mm
Lengths - 900mm, 1200mm
Hardened Steel



Toughlok™
35 Chain

Diameter - 5mm
Lengths - 900mm, 1200mm
Hardened Steel





High Security Hardened Alloy Steel Chains - Sold Secure Approved



Code	Security Rating	Sold Secure	Description	Dimensions mm		Barcode	Pack Type	Min Qty
				Link Diameter	Chain Length			
TC22/5	10	Motorcycle	TC Chain alloy steel hardened chain, blue sleeve	22	1500	5012245038378	TAG	1
TC19/5	10	Motorcycle	TC Chain alloy steel hardened chain, blue sleeve	19	1500	5012245035889	TAG	1
TC16/5	10	Motorcycle	TC Chain alloy steel hardened chain, blue sleeve	16	1500	5012245035896	TAG	1
TC14/3	10	Motorcycle	TC Chain alloy steel hardened chain, blue sleeve	14	915	5012245028089	TAG	1
TC14/4	10	Motorcycle	TC Chain alloy steel hardened chain, blue sleeve	14	1200	5012245028096	TAG	1
G3	9	Bicycle	G Chain alloy steel hardened chain, blue sleeve	10	915	5012245006537	TAG	1
G4	9	Bicycle	G Chain alloy steel hardened chain, blue sleeve	10	1200	5012245003116	TAG	1
G5	9	Bicycle	G Chain alloy steel hardened chain, blue sleeve	10	1500	5012245038590	TAG	1
G7	9	Bicycle	G Chain alloy steel hardened chain, blue sleeve	10	2000	5012245040630	TAG	1
J3	8	Bicycle	J Chain alloy steel hardened chain, blue sleeve	8	915	5012245008630	TAG	1
J4	8	Bicycle	J Chain alloy steel hardened chain, blue sleeve	8	1200	5012245004366	TAG	1

Hardened Steel Chains



Y3	7		Y Chain hardened steel, grey sleeve	10	900	5012245026597	TAG	1
Y4	7		Y Chain hardened steel, grey sleeve	10	1200	5012245026603	TAG	1
Y6	7		Y Chain hardened steel, grey sleeve	10	1800	5012245032628	TAG	1
X3	6		X Chain hardened steel, grey sleeve	8	900	5012245026573	TAG	1
X4	6		X Chain hardened steel, grey sleeve	8	1200	5012245026580	TAG	1
CP36P	5		CP Chain hardened steel chain, grey sleeve	6.5	900	5012245003345	TAG	1
CP48P	5		CP Chain hardened steel chain, grey sleeve	6.5	1200	5012245003352	TAG	1
3536C	4		Chain hardened steel, grey sleeve	5	900	5012245027655	TAG	1
3548C	4		Chain hardened steel, grey sleeve	5	1200	5012245027648	TAG	1

High Security Hardened Alloy Steel Chains - Sold Secure Approved - Lock And Chain Sets



SS100CS/TC22

Chain
Diameter - 22mm
Length - 1500mm

Padlock
 100mm body width
 closed shackle
 padlock



SS80CS/TC22

Chain
Diameter - 22mm
Length - 1500mm

Padlock
 80mm body width
 closed shackle
 padlock



SS80CS/TC19

Chain
Diameter - 19mm
Length - 1500mm

Padlock
 80mm body width
 closed shackle
 padlock



SS80CS/TC16

Chain
Diameter - 16mm
Length - 1500mm

Padlock
 80mm body width
 closed shackle
 padlock



SS65CS/TC14

Chain
Diameter - 14mm
Lengths - 915mm,
 1200mm

Padlock
 65mm body width
 closed shackle
 padlock



SS50CS/TC14

Chain
Diameter - 14mm
Lengths - 915mm,
 1200mm

Padlock
 50mm body width
 closed shackle
 padlock



DCL1/J3

Chain
Diameter - 8mm
Lengths - 915mm

Padlock
 70mm diameter disc
 lock





SS50CS/G4

Chain
Diameter - 10mm
Lengths - 1200mm

Padlock
50mm body width
closed shackle
padlock



SS50S/G3

Chain
Diameter - 10mm
Lengths - 915mm

Padlock
50mm body width
open shackle
padlock



3936

Chain
Diameter - 8mm
Lengths - 915mm

Padlock
51mm body width
open shackle
padlock



3536

Chain
Diameter - 8mm
Lengths - 915mm

Padlock
38mm body width
open shackle
padlock



CP50/36

Chain
Diameter - 8mm
Lengths - 915mm

Padlock
50mm body width
open shackle
combination
padlock

Hardened Steel Chain
Lock And Chain Sets





High Security Hardened Alloy Steel Chains - Sold Secure Approved - Lock And Chain Sets



Code	Security Rating	Sold Secure	Description	Link Diameter	Chain Length	Dimensions mm					Barcode	Key Blank	Pack Type	Min Qty	MK
						A	B	C	D	E					
SS100CS/TC22/5	10	Motorcycle	SS100CS padlock with hardened alloy chain	22	1500	100	62	20	33	28	5012245038835	KB P6	TAG	1	■
SS80CS/TC22/5	10	Motorcycle	SS80CS padlock with hardened alloy chain	22	1500	80	40	16	25	24	5012245038842	KB P6	TAG	1	■
SS80CS/TC19/5	10	Motorcycle	SS80CS padlock with hardened alloy chain	19	1500	80	40	16	25	24	5012245038859	KB P6	TAG	1	■
SS80CS/TC16/5	10	Motorcycle	SS80CS padlock with hardened alloy chain	16	1500	80	40	16	25	24	5012245038866	KB P6	TAG	1	■
SS65CS/TC14/3	10	Motorcycle	SS65CS padlock with hardened alloy chain	14	915	65	31.8	12.7	19	19	5012245029215	KB P6	TAG	1	■
SS65CS/TC14/4	10	Motorcycle	SS65CS padlock with hardened alloy chain	14	1200	65	31.8	12.7	19	19	5012245022346	KB P6	TAG	1	■
SS50CS/TC14/3	10	Motorcycle	SS50CS padlock with hardened alloy chain	14	915	50	26	10	16	16	5012245029222	KB P6	TAG	1	■
SS50CS/TC14/4	10	Motorcycle	SS50CS padlock with hardened alloy chain	14	1200	50	26	10	16	16	5012245029239	KB P6	TAG	1	■
SS50CS/G4	9	Bicycle	SS50CS padlock with hardened alloy chain	10	1200	50	26	10	16	16	5012245004045	KB P6	TAG	6	■
DCL1/J3	9	Bicycle	DCL1 Padlock with hardened alloy chain	8	915	70	27.5	9.5	17.5	17	5012245020106	KB P6	TAG	1	■
SS50S/G3	10	Motorcycle	SS50S Padlock with hardened alloy chain	10	915	50	26	10	26	22	5012245003536	KB6	TAG	1	■

Sold Secure accreditations have been either attained or applied for at the time of print. Therefore they are subject to change during the lifetime of this price list.

MK Indicates Masterkeyed available
Keyed Alike available



Hardened Steel Chain Lock And Chain Sets

3936	5	39 lock with hardened square link chain (X3)	8	915	51	29	9	24	24	5012245003642	KB P4	TAG	6	■
3536P	6	35 lock with hardened steel chain	5	900	38	23	7	17	16	5012245001587	KB P4	TAG	6	■
CP50/36	7	CP50 Combi with hardened square link chain (X3)	8	915	50	26	8	26	22.6	5012245027945	10000	TAG	6	■

SOLD SECURE

	DIAMOND
	GOLD
	SILVER
	BRONZE



GA5 Garage Door Protector Suitable for use on up and over garage doors

- Extra security for up and over garage doors
- Sold Secure Domestic Bronze approved and Secured by Design accredited
- High Security hardened steel construction
- 5 Pin tumbler lock mechanism
- Surface mounted, all in one, integrated product
- Tilt action arm locks into place to prevent garage door from being opened
- Supplied with all fixings
- Simple ground fitting in front of the garage door - Full fitting instructions included
- Once opened, drive straight over, no removal needed



GA5

GA5 Garage Protector

Code	Security Rating	@	Sold Secure	Description	Dimensions mm			Barcode	Pack Type	Min Qty
					Length	Width	Closed Height			
GA5	10	@HOME	Domestic	GA5 Garage Door Protector	320	100	221	5012245038439	BOX	1

Ground and Wall Anchors



10+
security rating

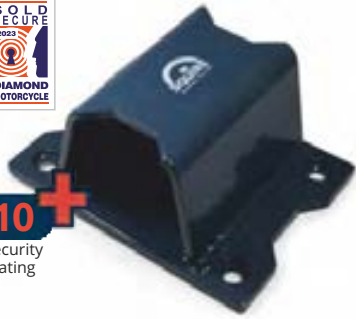

GA6 Ground Anchor

- Sold Secure Diamond Motorcycle approved
- Single bridge anchor
- Fully case hardened product to RC 60 spec. Solid construction
- Supplied with four security fixing bolts, steel ball inserts
- Blue powder coated finish
- Fits chains up to 22mm



new



GA7 Ground Anchor

- Sold Secure Gold Motorcycle and Sold Secure Diamond Bicycle Approved
- Single bridge anchor
- Fully case hardened product to RC 60 spec. Solid construction
- Supplied with four security fixing bolts, steel ball inserts
- Blue powder coated finish
- Fits chains up to 19mm



WA500 Wall anchor

- Sold Secure Gold Bicycle Approved
- For internal and external use
- Hardened steel 5mm construction
- Powder coated
- Easy to fit
- Supplied with security fittings
- Best for SQUIRE chains up to 10mm



WA300 Wall anchor

- Sold Secure Gold Bicycle Approved
- For internal and external use
- Hardened steel 5mm construction
- Powder coated
- Easy to fit
- Supplied with security fittings
- Best for SQUIRE chains up to 8mm

SOLD SECURE

	DIAMOND		SILVER
	GOLD		BRONZE

Code	Sold Secure	Security Rating	Suitable for motorcycles	Description	Dimensions mm				Barcode	Pack Type	Min Qty
					Width	Height	Length	Clearance			
GA6	Motorcycle	10+	Yes	High Security Bridge Ground anchor	200	92	150	73 x 76	5012245038330	BOX	1
GA7	Motorcycle	10	Yes	High Security Bridge Ground anchor	160	75	120	65 x 60	5012245038606	BOX	1
WA500	Bicycle	8		Security Bridge Wall Anchor	283	137	77	58 x 43	5012245036985	PLATFORM	1
WA300	Bicycle	5		Bridge Wall Anchor	219	113	48	37 x 31	5012245036992	PLATFORM	1

Sold Secure accreditations have been either attained or applied for at the time of print. Therefore they are subject to change during the lifetime of this price list.

KILDA Cable locks and **FOLDA** Folding lock **NEW**



KILDA Key operated cable locks and integrated lock and chain

- Cable locks available in 10mm, 12mm and 15mm diameters - 1800mm length
- Integrated chain lock with 6mm link diameter - 900mm length
- Disc tumbler lock mechanism
- Protective dust cover on keyway
- Comes with 3 keys
- Carrying bracket included



KILDA Combination cable locks and integrated lock and chain

- Cable locks available in 10mm and 12mm diameters - 600mm and 1800mm lengths
- Integrated chain lock with 6mm link diameter - 900mm length
- 4 Wheels, 10,000 possible combinations
- Fully recodable
- Carrying bracket included



FOLDA Folding locks

- FL850 is Sold Secure Bronze Bicycle Approved
- Compact, easy to carry, easy to use
- Hardened steel links
- Disc tumbler lock mechanism
- Available in two sizes 850mm length and 690mm length
- Carrying bracket included



10C and 12C Extender security cables

- Available in 10mm diameter and 12mm diameter
- 1800mm length
- Multi-strand cable with looped ends
- Recommended for use with a suitable Squire D-lock or padlock

KILDA Key Operated Locks

Code	Security Rating	Description	Cable diameter/ Chain link diameter	Length	Barcode	Key Blank	Pack Type	Min Qty
KILDA 10/600	3	Key operated cable lock 10mm x 600mm	10mm	600mm	5012245039450	n/a	CARD	6
KILDA 10/1800	3	Key operated cable lock 10mm x 1800mm	10mm	1800mm	5012245039443	n/a	CARD	6
KILDA 12/1800	4	Key operated cable lock 12mm x 1800mm	12mm	1800mm	5012245039467	n/a	CARD	6
KILDA 15/1800	5	Key operated cable lock 15mm x 1800mm	15mm	1800mm	5012245039474	n/a	CARD	6
KILDA CN6/900	5	Key operated Integrated chain lock 6mm x 900mm	6mm	900mm	5012245039481	n/a	CARD	6

KILDA Combination Locks

Code	Security Rating	Description	Cable diameter/ Chain link diameter	Length	Barcode	No of Combinations	Pack Type	Min Qty
KILDA COMBI 10/600	3	Recodeable cable lock 10mm x 600mm	10mm	600mm	5012245039504	10,000	CARD	6
KILDA COMBI 10/1800	3	Recodeable cable lock 10mm x 1800mm	10mm	1800mm	5012245039498	10,000	CARD	6
KILDA COMBI 12/1800	4	Recodeable cable lock 12mm x 1800mm	12mm	1800mm	5012245039511	10,000	CARD	6
KILDA COMBI CN6/900	5	Recodeable Integrated chain lock 6mm x 900mm	6mm	900mm	5012245039528	10,000	CARD	6

FOLDA Folding Lock

Code	Security Rating	Sold Secure	Description	Length	Barcode	Pack Type	Min Qty
FOLDA FL690	6		Folding Lock 690mm	690mm	5012245039542	CARD	6
FOLDA FL850	7	Bicycle	Folding Lock 850mm	850mm	5012245039535	CARD	6

Extender Cables

Code	Security Rating	Description	Cable diameter	Length	Barcode	Pack Type	Min Qty
10C	3	Looped Extender Cable 10mm x 1800mm	10mm	1800mm	5012245007589	CARD	6
12C	4	Looped Extender Cable 12mm x 1800mm	12mm	1800mm	5012245007572	CARD	6



Old English



Model nos.
220 and Keybolt PET



Key Code
KB 220



Model nos.
440 PEF



Key Code
KB 440



Model nos.
660 PES



Key Code
KB 660

DCL1



Model nos.
Discus Locks (New Style) DCL1



Key Code
KB DCL N

Lion



Model nos.
LN2



Key Code
KB LN A SL



Model nos.
New All Terrain ATL42S, ATL52S
Lion LN3, LN4, LN4S, LN4/2.5, LN5, LN60
Warehouse WL2, WL3, ASWL 1, ASWL 2
P5 Range SS50P5, SS50CP5, WS50P5
P5 Marine version
Powerlok POL45, POL45CS, POL55, POL55CS
D Lock Hammerhead
Mako Conger, AD25, CN8, CN6, 25mm, 18mm, 14mm



Key Code
KB LN C SL

Locking Hasp



Model nos.
LH1



Key Code
KB LH1

Leopard



Model nos.
LP6, LP7



Key Code
KB LP A SL



Model nos.
LP8, LP8/2



Key Code
KB LP B SL



Model nos.
LP9,
LP10, LP60



Key Code
KB LP C SL

Stronglock Pin Tumbler



Model nos.
Stronglock Pin Tumbler 35, 37, 37CS, 37/2.5, 39, 39CS, 39/2.5
Vulcan Range VULCAN P4 40, P4 45, P50 -All shackle types
D-Lock CH260



Key Code
KB P4 (formerly KB O2)

All Terrain (old style)



Model nos.
ATL4, ATL5, ATL4S, ATL5S

Key Code
KB ATL4/5

GarageGuard



Model nos.
GARAGEGUARD

Key Code
KB GARAGE GUARD



Model nos.
Lion LN3, LN4, LN4S, LN4/2.5, LN5, LN60
Warehouse WL2, WL3, ASWL 1, ASWL 2
P5 Range SS50P5, SS50CP5, WS50P5
WARRIOR WAR65, WAR55, WAR45 - All shackle types
D Lock Hammerhead
Mako Conger, AD25, CN8, CN6, 25mm, 18mm, 14mm

Key Code
KB P5

Stronghold Hi-Security



Model nos.
Stronghold Hi-Security SS80, SS80CS, SS65S, SS65CS, WS75, WS50, SS50S, SS50CS, HLS50, SS65/2.5, SS50 MARINE VERSIONS

Key Code KB P6 (formerly CYKEY/SI/BL)

Stronghold R1 Restricted Range



Model nos.
Cut Key for restricted cylinders and locks

Key Code
CYKEY/R1/BL

Stronghold E1 Dimple Pin



Model nos.
Stronghold Hi-Security SS80, SS80CS, SS65S, SS65CS, WS75, SS50S, SS50CS, SS65/2.5, SS50/2.5

Key Code
CYKEY/E1/BL

Key Blanks

Code	Description	Barcode
KBLN A SL	Keyblank for 20 & 25 Lion brass	Special
KBLN C SL	Keyblank for LN / DCL / P5 / WL / ASWL / WAR	Special
KBLP A SL	Keyblank for 20 & 25 Leopard Brass	Special
KBLP B SL	Keyblank for 30 Leopard Brass	Special
KBLP C SL	Keyblank for 40, 50, 60, 70 Leopard Brass	Special
KBATL4/5	Keyblank for All Terrain (Old style)	Special
KB 220	Keyblank for Old English (220)	Special
KB 440	Keyblank for Old English (440)	Special
KB 660	Keyblank for Old English (660)	Special
KB 02	Keyblank for Laminated stronglock, (same as KB P4)	Special
CYKEY/S1/BL	Keyblank for Stronghold 6 pin	Special
CYKEY/E1/BL	Keyblank for Stronghold 6 pin E1 Profile	Special
KBLH1	Keyblank for Locking Hasp	Special
KB DCL N	Keyblank for DCL1	Special
CYKEY/R1/BL	Keyblank for restricted cylinders	Special
KB GARAGE GUARD	Keyblank for Garage Guard	Special
KB P4	Key Blank P4 (4-Pin) Laminated padlocks (same as KB 02)	Special
KB P5	Key Blank P5 (5-Pin) padlocks	Special
KB P6	Key Blank P6 (6-Pin) Stronghold Padlocks (same as CYKEY/S1/BL)	Special

Cut Keys

Code	Description	Barcode
CK660	Cut key for 660 Old English	Special
CK440	Cut key for 440 Old English	Special
CK220	Cut key for 220 Old English	Special
CK02	Cut key for Laminated Stronglock	Special
CKATL	Cut key for All Terrain padlocks	Special
CKLN	Cut key for Lion padlocks	Special
CKLP	Cut key for Leopard padlocks	Special
CYKEY/S1/CK	Cut key for Stronghold 6 pin	Special
CYKEY/E1/CK	Cut key for Stronghold 6 pin E1 Elite Dimple	Special
CYKEY/R1/CK	Cut Key for restricted cylinders	Special
MK	Cut Master Key for all ranges except S1/E1/R1	Special
MKS1	Cut Master Key for S1 Profile	Special
MKE1	Cut Master Key for E1 Profile	Special
MKR1	Cut Master Key for R1 Profile	Special
CKP4	Cutkey for P4 (4-Pin) Laminated Padlocks (Same as KB 02)	Special
CKP5	Cutkey for P4 (5 Pin) Padlocks	Special
CKP6	Cutkey for P6 (6-Pin) Stronghold Padlocks (Same as CYKEY/S1/CK)	Special

BP85 Merchandiser

BP85

A free merchandiser is available as part of a stocking deal covering 50+ lines.

Speak to your representative.



BP85 Specification

Height	2050mm
Depth	550mm
Width	1000mm
Colour	Blue and Gold

BP65 Merchandiser

BP65

A free merchandiser is available as part of a stocking deal covering 40+ lines.

Speak to your representative.



BP65 Specification

Height	2050mm
Depth	550mm
Width	650mm
Colour	Blue and Gold

BP40 Merchandiser - Hardware Key and Combination versions

BP40

A free merchandiser is available as part of a stocking deal covering 20+ lines.

Squire customers can choose:
BP40 Hardware key operated locks

BP40 Hardware combination locks

BP40 Combination and Key - combined

Speak to your representative.



BP40 Specification

Height	1780mm
Depth	495mm
Width	430mm
Colour	Blue and Gold

CTDUCPBOXED Counter top merchandiser

Can be used on counter or hung from slat wall
4+ lines CP50, CP50 ATL, CP50S and Vulcan Combi 50

Speak to your representative.



CTDUCPBOXED Specification

Height	530mm
Depth	152mm (excluding feet)
Width	360mm
Colour	Blue / printed graphics

New Stronghold® SS100 POS board

The **SS100** is the newest addition to Squire's **Stronghold®** range. These stunning locks are now available on a Point of Sale, merchandiser board. Both versions, the open and closed version are displayed, fixed to a strong bracket. The board comes with 'J' Hooks supplied and loops prefixed to the back of the board for easy installation.



SS100 POS Specification

Width	800mm
Height	480mm
Depth	50mm approx
Colour	Printed graphics

New Combi-Bolt® POS board

The **Combi-Bolt®** range is a highly popular and successful group of products. All 5 versions of the **Combi-Bolt®** are displayed on the Point of sale board. The board is made from lightweight di-bond and comes with hanging brackets affixed for easy installation. All **Combi-Bolts®** are pre-fixed to the board with security head screws.



CombiBolt POS Specification

Width	620mm
Height	420mm
Depth	50mm approx
Colour	Printed graphics

CT10 - Counter top POS Units



The **Squire** CT10 Counter top POS units offer an attractive display in stores with limited space. Neat and compact, Squire offer these across a number of product ranges such as, Vulcan, CP Combination, Old English 555, Keysafes plus many more. Squire also offer a generic Squire branded version so that customers can choose their own offering and mix and match across ranges. Please speak to your local representative to find out more.

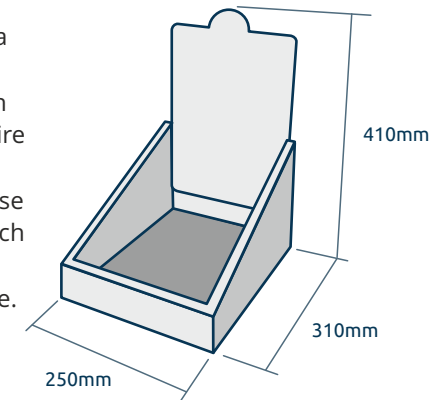

Terms and conditions

In these Conditions “the Company” shall mean Henry Squire & Sons Ltd and “the Goods” shall mean and includes goods and/or works (including all workmanship) or any part thereof of any description to be performed under this Contract.

Formation of Contract

- 1.1.1. All quotations, offers and tenders are made and all orders are accepted subject to the following Conditions. All other terms, conditions or warranties whatsoever are excluded from any contract between the Company and the Customer unless expressly accepted in writing by a director or other authorised representative of the Company.
- 1.1.2. In the event of a conflict between these Conditions and the Company’s express terms of any tender, quotation or order acknowledgement then such express terms shall prevail.
- 1.2. Quotations, offers and tenders issued by the Company are for the whole of the goods referred to in them and the Company reserves the right to refuse acceptance of any order which relates to only part of the Goods forming the subject of a quotation, offer or tender.
- 1.3. Quotations shall be available for acceptance for a maximum period of 30 days from the date of issue and may be withdrawn by the Company at any time prior to the Customer’s acceptance by written or oral notice.
- 1.4. If any statement or representation has been made to the Customer by the Company, or its employees, officers or agents upon which the Customer relies (other than in the document[s] enclosed with the Company’s quotation or acknowledgement of order) then the Customer must set out that statement or representation in a document to be attached to or endorsed on the order and in any such case the Company may confirm, reject or clarify the point and submit a new quotation, if appropriate. Under no circumstances shall the Company be responsible or held liable in respect of any statement or representation relied upon by the Customer which is not endorsed on the order and subsequently confirmed in writing by the Company.
- 1.5. Unless specifically agreed to the contrary all trade terms shall be interpreted in accordance with the INCOTERMS current at the time the order is accepted.

Prices

- 2.1. Unless otherwise stated in writing, all prices are quoted nett ex works and VAT, where appropriate, is payable in addition.
- 2.2. Unless otherwise agreed in writing, carriage will be paid on all orders of a nett value of £145 or over for despatch to points within the United Kingdom by the Company’s usual means of carriage. Orders of a nett value less than £145 may also be despatched but the carriage charge will be debited on the invoice.
- 2.3. Where, at the Customer’s request, orders are forwarded by any means involving a higher carriage charge than would be incurred by use of the Company’s usual means of carriage then the additional charge will be debited on the invoice.
- 2.4. Quoted prices are subject to fluctuation and the price payable for the Goods shall be the standard trade price of the Company as published in its recommended retail price list (less any agreed discounts) in force at the time of delivery.
- 2.5. In the event of any alteration being requested by the Customer in design or specification and agreed to by the Company, the Company shall be entitled to make an adjustment to the quoted price fairly reflecting such alteration.

Payment

- 3.1. Unless otherwise agreed by the Company in writing and subject to satisfactory trade references, payment shall be due and payable by the end of the month following the month in which the invoice was issued, a cash discount of 1.5% will be allowed on all invoices that are paid by the due date unless otherwise stated.
- 3.2. The Company shall be entitled to submit its invoice with its delivery advice note or at

- any time afterwards save that where delivery has been postponed at the request of or by the default of the Customer then the Company may submit its invoice at any time after the Goods are ready for delivery or would have been ready in the ordinary course but for the request or default on the part of the Customer.
- 3.3. Where Goods are delivered by instalments the Company may invoice each instalment separately and the Customer shall pay such invoices in accordance with these Conditions.
- 3.4. No disputes arising under the contract nor delays beyond reasonable control of the Company shall interfere with prompt payment in full by the Customer.
- 3.5. In the event of default in payment by the Customer the Company shall be entitled, without prejudice to any other right or remedy:
 - 3.5.1. to suspend all further deliveries on any contract or contracts between the Company and the Customer without notice.
 - 3.5.2. to charge interest on any amount outstanding at the rate of either 2% per annum above the Base Rate of Barclays Bank plc such interest being charged as a separate continuing obligation not merging with any judgement; and/or
 - 3.5.3. to serve notice on the Customer requiring immediate payment for all Goods supplied by the Company under this and all other contracts with the Customer whether or not payment is otherwise due.
- 3.6. All payments received by the Company from the Customer may unless specifically appropriated by the Customer to any particular consignment of Goods be appropriated by the Company as it thinks fit.

Delivery

- 4.1. Time for delivery is given as accurately as possible but is not guaranteed. The Customer shall have no rights to damages or to cancel the order for failure for any cause to meet any delivery time stated.
- 4.2. Failure by the Customer to take delivery of or to make payment in respect of any one or more instalments of Goods delivered under the contract shall entitle the Company to treat the whole or part of the contract as repudiated by the Customer.
- 4.3. The Company will endeavour to comply with reasonable requests by the Customer for postponement of delivery but shall be under no obligation to do so. Where delivery is postponed, otherwise than due to the default by the Company, the Customer shall pay all costs and expenses so occasioned and payment for the Goods shall be made in accordance with these Conditions.
- 4.4. Any packaging supplied by the Company, unless otherwise expressly agreed in writing, is intended to provide adequate protection in normal conditions of transit of usual duration.
- 4.5. Section 32(2) and (3) of the Sale of Goods Act 1979 shall not apply.

Minimum Orders and Packing

- 5.1. Unless otherwise agreed in writing orders must conform to minimum standard pack quantities shown in the Company’s current price list. Where smaller than standard pack quantities are ordered for any Goods this quantity will be increased to conform to the nearest pack multiple.
- 5.2. Presentation-packed products will be sent against all orders unless the Customer states on the face of the order that carton-pack is required.

Risk and Title

- 6.1. Risk shall pass to the Customer so that the Customer is responsible for all loss, damage or deterioration to the Goods;
 - 6.1.1. if the Company delivers the Goods by its own transport or in accordance with a specific contractual obligation arranges transport for the Goods at the time when they arrive at the designated place of delivery, or
 - 6.1.2. in all other circumstances at the time when the Goods leave the premises of the Company.
- 6.2. Title to the Goods shall only pass to the Customer upon the happening of any one of the following events:
 - 6.2.1. the Customer has paid to the Company all sums (including any default interest) due from it

- to the Company under this contract and under all other contracts between the Company and the Customer including (for the avoidance of doubt) any sums due under contracts made after this contract whether or not the same are immediately payable, or of doubt) any sums due under contracts made after this contract whether or not the same are immediately payable, or under contracts made after this contract whether or not the same are immediately payable, or of doubt) any sums due under contracts made after this contract whether or not the same are immediately payable, or when the Company serves on the Customer notice in writing specifying that title in the Goods has passed.
- 6.2.2. The Company may recover Goods in respect of which title ny premises of the Customer for the purpose either of satisfying itself that Condition 6.4 is being complied with by the Customer or of recovering any Goods in respect of which title has not passed to the Customer.has not passed to the Customer at any time and the Customer hereby licenses the Company, its officers, employees and agents to enter upon any premises of the Customer for the purpose either of satisfying itself that Condition 6.4 is being complied with by the Customer or of recovering any Goods in respect of which title has not passed to the Customer.
- 6.4. Until title to the Goods has been passed to the Customer pursuant to these terms it shall possess the Goods as fiduciary agent and bailee of the Company. If the Company so requires, the Customer shall store the Goods separately from other goods and shall ensure that they are clearly identifiable as belonging to the Company.

Cancellation and Return of Goods

- 7.1. Cancellation by the Customer will only be agreed to by the Company on condition that all costs and expenses incurred by the Company up to the time of cancellation and all loss of profits and other loss or damage resulting to the Company by reason of such cancellation will be paid forthwith by the Customer to the Company.
- 7.2. Goods returned to the Company without the Company’s consent will under no circumstances be accepted for credit. Goods will only be accepted if they are, in the sole opinion of the Company, in good saleable condition and remain upon the Company’s current price list. An inspection and handling fee will be charged on such Goods.

Sale by Sample

8. Notwithstanding that samples may be or have been submitted by the Company the sale to the Customer is not and shall not be deemed to be a sale by sample for the purposes of Section 15 of the Sale of Goods Act 1979. Any samples submitted to the Customer are intended to indicate only the substance and the general character of the materials and the Customer shall have no claim if the colour composition of the bulk supplied fails to correspond with the sample in such respect unless the particular requirement is specified by the Customer and accepted by a director or other authorised representative of the Company in writing.

Specification

9. The information contained in the advertising, sales and technical literature issued by the Company may be relied upon to be accurate in the exact circumstances in which it is expressed otherwise any illustrations, performance details, examples of installations and methods of assembly and all other technical data in such literature are based on experience and on trials under test conditions and are provided for general guidance only. No such information or data shall form part of the contract unless the Customer shall have complied with Condition 1.4. relating to statements and representations.

Loss Shortages and Defects Apparent on Inspection

- 10.1. The Customer shall have no claim for loss, shortages or damage on delivery which are or would be apparent on visual inspection unless:
 - 10.1.1. the Customer inspects the Goods within three working days of their arrival at its

Terms and conditions

- premises or other agreed destination, and
- 10.1.2.** a written complaint specifying the loss, shortage or damage is made to the Company and to the carrier within seven working days of delivery in the event of partial loss, damage, or non-delivery of any separate part of a consignment, or within fourteen working days of the notified date of despatch in the event of non-delivery of a whole consignment or, in either event, within such shorter period as the carrier's conditions (if applicable) require, and
- 10.1.3.** The Company is given an opportunity to inspect the Goods and investigate any complaint before any use of or alteration to or interference with the Goods.
- 10.2.** If a complaint is not made to the Company as provided in this Condition 10 then the Goods will be deemed to be in all respects in accordance with the contract and the Customer shall be bound to pay for the same accordingly.
- 10.3.** Defects in any instalment delivery shall not be a ground for cancellation of the remainder of the order.

Defects not Apparent on Inspection

- 11.1.** The Customer shall have no claim in respect of defects not apparent on visual inspection following delivery conditions unless envisaged by these Conditions unless:
- 11.1.1.** a written complaint is sent to the Company as soon as reasonably practicable after the defect is discovered and no use is made of the Goods thereafter and no alteration made thereto or interference made therewith before the Company is given an opportunity to inspect the Goods in accordance with this Condition.
- 11.2.** The Customer shall not be entitled to any claim in respect of any repairs or alterations undertaken by the Customer without the prior specific written consent of the Company nor in respect of any defect arising by reason of fair wear and tear or damage due to accident, neglect or misuse nor in respect of any Goods to which alterations have been made without such consent or to which replacement parts not supplied by the Company have been fitted.
- 11.3.** The Company shall not be liable for and the Customer shall indemnify the Company against claims arising from their loss or damage suffered by reason of use of the Goods after the Customer becomes aware of a defect or after circumstances which should reasonably have indicated to the Customer the existence of a defect.
- 11.4.** The Company may within 15 working days of receiving a written complaint (or 28 days where the Goods are situated outside the United Kingdom) inspect the Goods and the Customer, if so required by the Company, shall take all steps necessary to enable the Company to do so.

Guarantee Condition

- 12.1.** Save as otherwise provided by the other conditions of these Conditions Sections 13 to 15 of the Sale of Goods Act 1979 are to be implied into the contract.
- 12.2.** In the event of the condition of the Goods being such as might or would (subject to these Conditions) entitle the Customer to claim damages, to repudiate the contract and/or reject the Goods the Customer shall not then do so but shall first ask the Company to repair or supply satisfactory substitute Goods and the Company shall thereupon be entitled at its option to repair or take back the defective Goods and to supply satisfactory substitute Goods free of cost and within a reasonable time or to repay the price of the Goods in respect of which the complaint is made.
- 12.3.** If the Company does so repair the Goods or supply satisfactory substitute Goods or effect repayment pursuant to Condition 12.2. above the Customer shall be bound to accept such repaired or substituted goods or repayment and the Company shall be under no liability in respect of any loss or damage whatsoever arising from the initial delivery of the defective Goods or from the delay before the defective Goods are repaired or the substitute Goods are delivered or the repayment is effected.

Liability

- 13.** Save where the Company is shown to have failed to exercise reasonable care in the manufacture and/or supply of the Goods and such failure results in death repaired or

substitute Goods) loss of profits, damage to property or wasted expenditure and costs (including without limitation legal costs on a full indemnity basis and VAT). or personal injury, the Company shall not be liable in respect of claims arising by reason of death or personal injury. Further, under no circumstances whatsoever shall the Company be liable for consequential loss (including removal or rectification work required in connection with the installation of repaired or substitute Goods) loss of profits, damage to property or wasted expenditure and costs (including without limitation legal costs on a full indemnity basis and VAT). be liable for consequential loss (including removal or rectification work required in connection with the installation of repaired or substitute Goods) loss of profits, damage to property or wasted expenditure and costs (including without limitation legal costs on a full indemnity basis and VAT).

Confidential Information and Industrial Property Rights

- 14.1.** All drawings, documents, confidential records, computer software and other information supplied by the Company are supplied on the express understanding that copyright is reserved to the Company and that the Customer will not, without the written consent of the Company, either give away, loan, exhibit or sell any such drawings, documents, records, software or other information or extracts there from or copies thereof or use them in any way except in connection with the Goods in respect of which they are issued.
- 14.2.** All claims for alleged infringement in respect of patents, trade marks, registered design, design right or copyright received by the Customer must be notified immediately to the Company so that the Company can be kept fully informed of the conduct of such claims, trade marks, registered design, design right or copyright received by the Customer must be notified immediately to the Company so that the Company can be kept fully informed of the conduct of such claims.

Customers' Drawings

- 15.1.** The Customer shall be solely responsible for ensuring that all drawings, information, advice and recommendations given to the Company, either directly or indirectly by the Customer's agents, servants, consultants, or advisers are accurate, correct and suitable. Examination or consideration by the Company of such drawings, information, advice or recommendations shall in no way limit the Customer's responsibility hereunder unless a director or other authorised officer of the Company specifically agrees in writing to accept responsibility.
- 15.2.** The Customer shall indemnify the Company from and against all actions, claims, costs and proceedings which arise due to the manufacture of Goods to the drawings or specifications of the Customer where such drawings or specifications are at fault or where it is alleged that they involve an infringement of a patent, copyright, registered design, design right or design copyright or other exclusive right.

Insolvency

- 16.** If the Customer shall become bankrupt or under the provisions of Section 123 of the Insolvency Act 1986 is deemed to be unable to pay its debts or compounds with creditors or in the event of a resolution being passed or proceedings commenced for the administration or liquidation of the Customer (other than for a voluntary solvent winding up for the purposes of reconstruction or amalgamation) or if a Receiver or Manager is appointed for all or any part of its assets or undertaking, the Company shall be entitled to cancel the contract in whole or in part by notice in writing without prejudice to any other right or remedy accrued or accruing to the Company.

Force Majeure

- 17.1.** In the event of the performance of any obligation accepted by the Company being prevented, delayed, or in any way interfered with by either:
- 17.1.1.** direction of government, war, industrial dispute, strike, breakdown or machinery or plant, accident, fire or by any other cause beyond the Company's control, or
- 17.1.2.** non-delivery by the Company's suppliers or damage to or destruction of the whole date of

suspension or cancellation. or part of the Goods, the company may at its option suspend performance or cancel its obligations under the contract without liability for any damage or consequential loss resulting there from such suspension or cancellation being without prejudice to the Company's right to recover all sums owing to it in respect of consignments delivered and costs incurred prior to the date of suspension or cancellation.

Consumer Protection Act 1987 ("the Act")

- 18.1.** In circumstances where the Company supplies parts or products to the Customer for incorporation with, or use ancillary to, any composite or other products to be produced, manufactured, processed or supplied by the Customer then:
- 18.1.1.** the Customer shall forthwith on demand produce for inspection by the Company copies of all written instructions, information and warnings to be supplied by the Customer in relation to the said composite or other products, provided nevertheless that such inspection or right to inspect shall not of itself constitute acceptance or approval on the part of the Company of such instructions, information or warnings, and
- 18.1.2.** the Customer shall indemnify, reimburse and compensate the Company for all losses and damages (including costs, expenses and charges for legal actions in which the Company may be involved) that the Company may incur in the event that any claim or claims are made against the Company pursuant to the Act or otherwise relating to the said composite or other products of the customer in circumstances in which the part or product supplied by the Company was either (i) not the defective part of the said composite product, or (ii) was only rendered the defective part or became a defective product by reason or actions or omissions of the Customer (including without limitation the supply of defective free issue materials), or (iii) was only rendered the defective part or became a defective product by reason of instructions or warnings given by the Customer or other supplier of the said composite or other products or (iv) supplied in accordance with a specification and/or drawings furnished by or on behalf of the Customer. defective product by reason of instructions or warnings given by the Customer or other supplier of the said composite or other products or (iv) supplied in accordance with a specification and/or drawings furnished by or on behalf of the Customer.
- 18.1.3.** for the purpose of this condition only the word "defective" shall be interpreted in accordance with the definition of 'defect' contained in Part 1 or the Act.
- 18.2.** The Customer hereby acknowledges that it is under a duty to pass on to its customers (where appropriate) all instructions, information and warnings supplied to it by the Company with the Goods.

Assignment

- 19.** The contract is between the Company and the Customer as principles and under no circumstances shall the Customer assign the benefit or burden of it without the prior written consent of the Company. The Company shall be entitled to assign or sub-contract the whole or part of its obligations under the contract.

Severability

- 20.** In the event of any provision of these Conditions being or becoming void in whole or part of the other other provisions of these conditions shall remain fully valid and enforceable and void provisions shall, where appropriate, be replaced in accordance with the meaning and purpose of these Conditions.

Legal

- 21.** The contract shall be governed and interpreted exclusively according to the law of England and shall be subject to the jurisdiction of the English Courts only.



240|YEARS

OF LOCKMAKING EXCELLENCE

www.squirelocks.co.uk

Henry Squire & Sons Limited, Hilton Cross Business Park, Cannock Road, Featherstone, Wolverhampton, WV10 7QZ

Tel: +44 (0)1902 308050

E-Mail: info@henry-squire.co.uk